

Cuaderno de Actividades
para el Verano
Educación Infantil 3 años

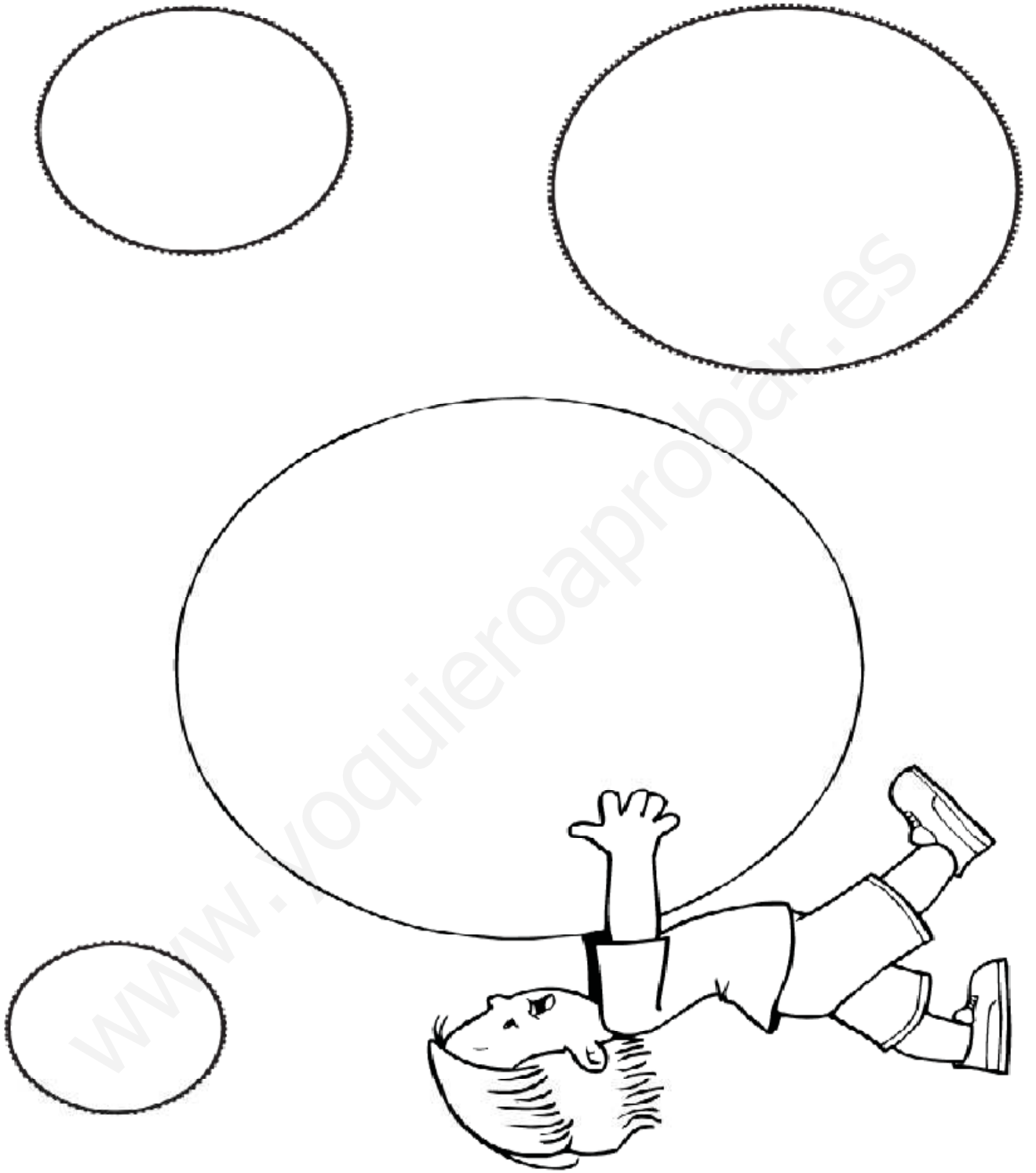

FORMAS GEOMÉTRICAS

www.yoquieroaprobar.es





NOMBRE:

Dashed rectangular box for writing the name.

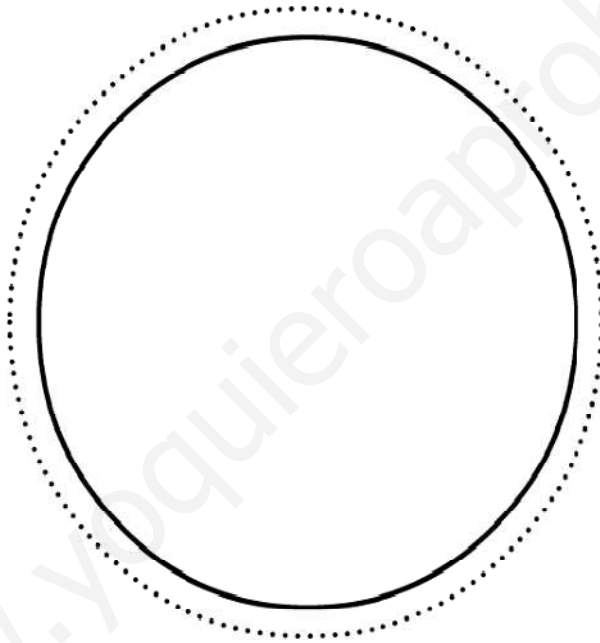

Círculo

CÍRCULO



Colorea la figura y pica por la línea de puntos.



NOMBRE:

Dashed rectangular box for writing the name.

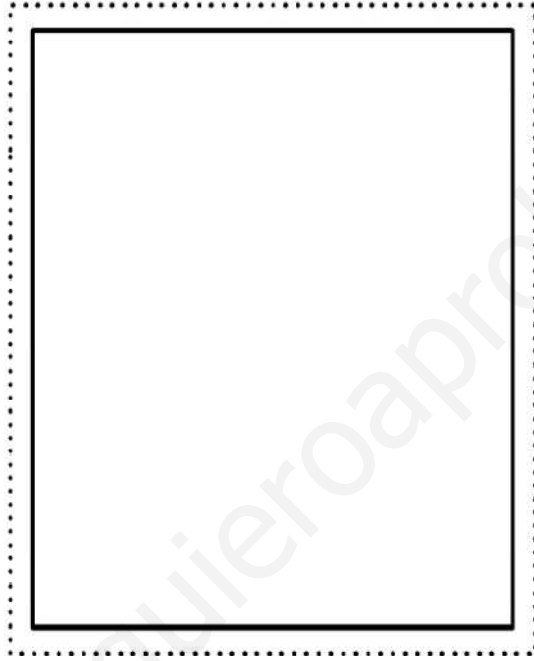

Cuadrado

CUADRADO



Colorea la figura y pica por la línea de puntos.

www.yoquieroaprobar.es



NOMBRE:

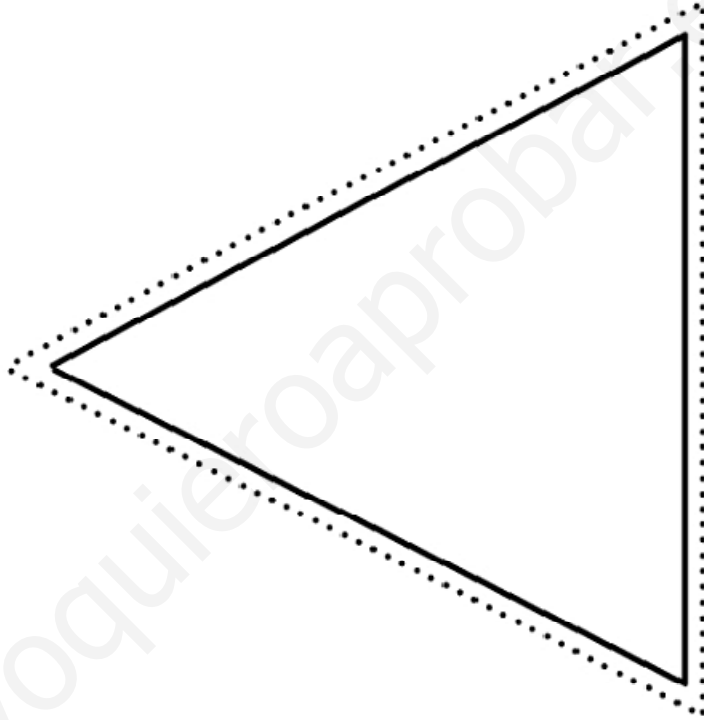

Triángulo

TRIÁNGULO

www.yoquieroaprobar.es



Tarea: Reconocemos los círculos.
Técnica: Colorear con ceras duras.



CRA Los Llanos

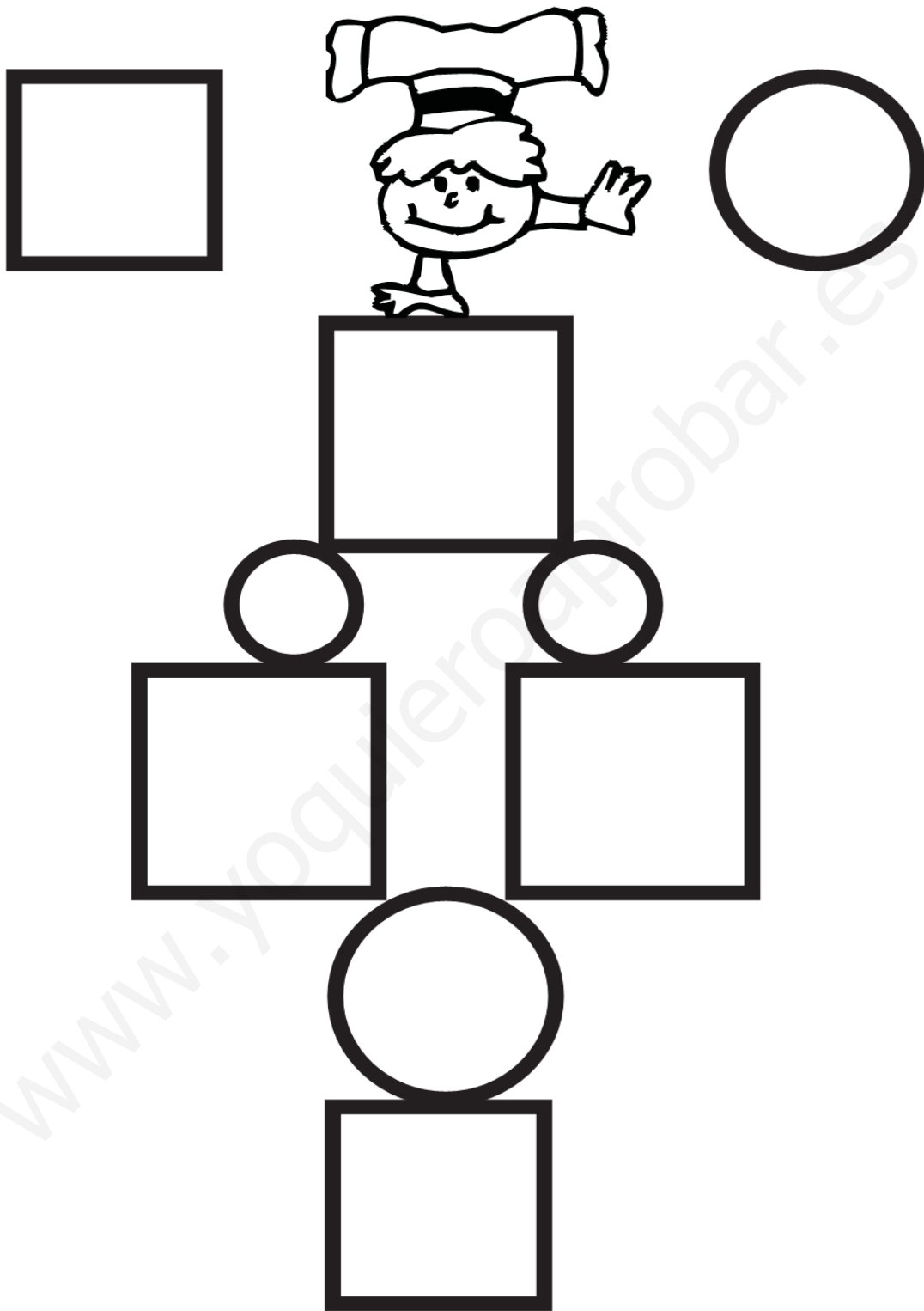

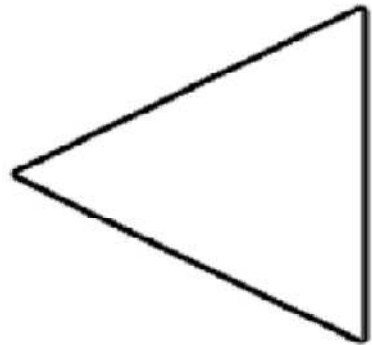
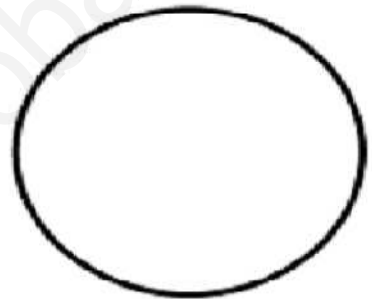
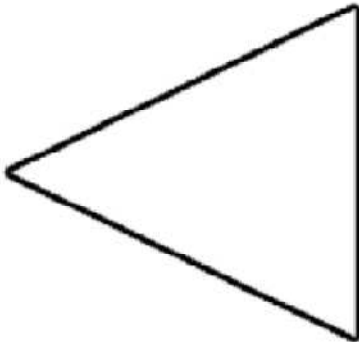
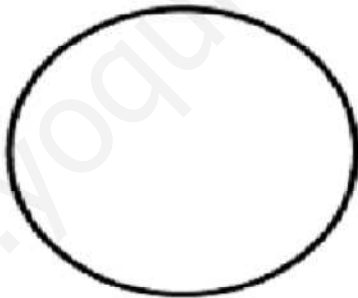
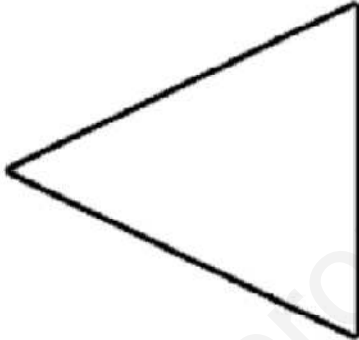
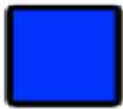
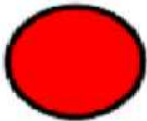
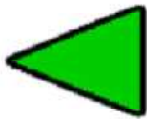

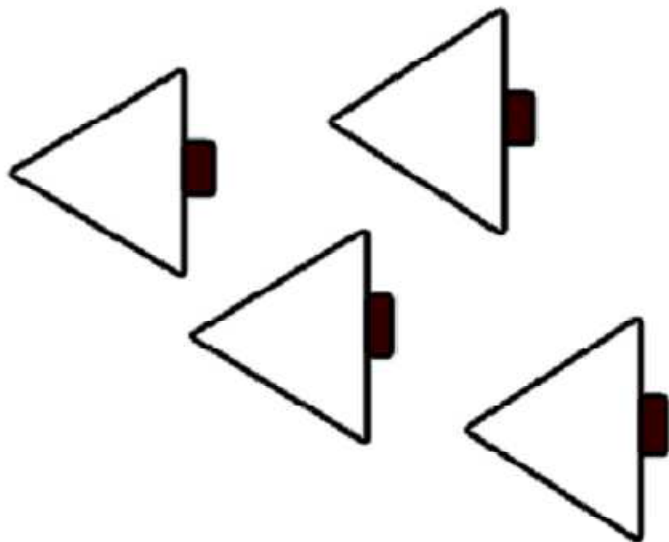
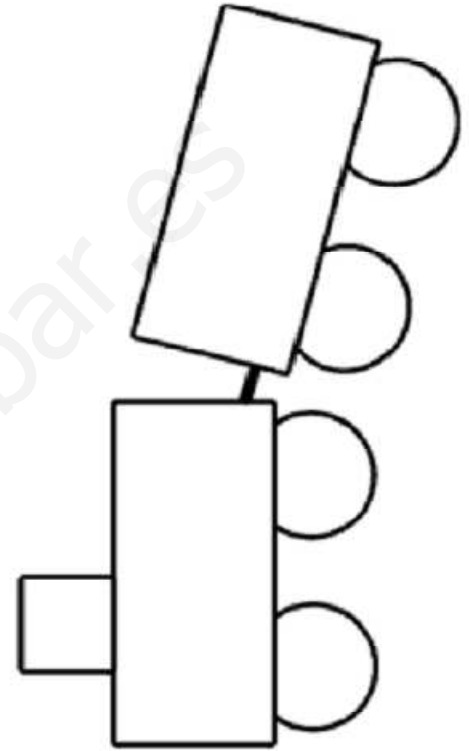
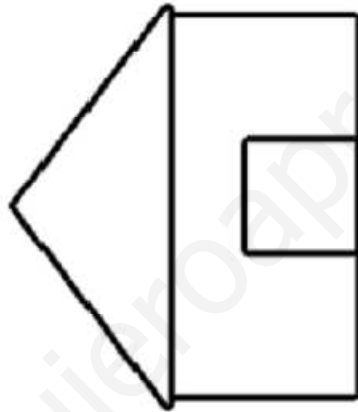
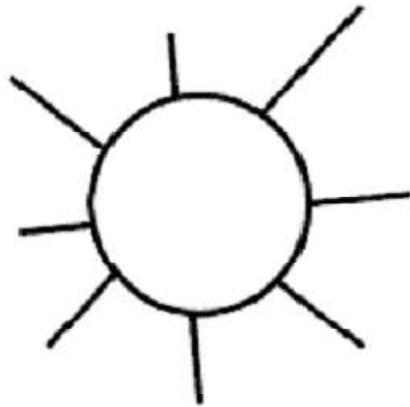

LOS NÚMEROS

1, 2 y 3

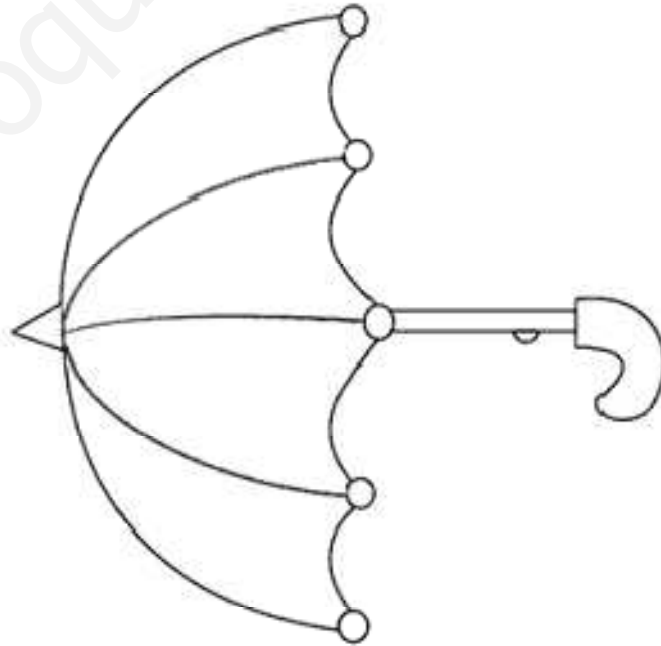
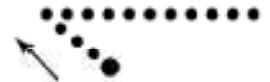
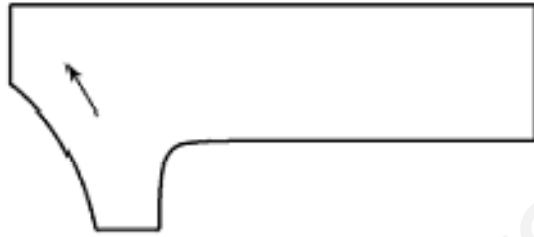

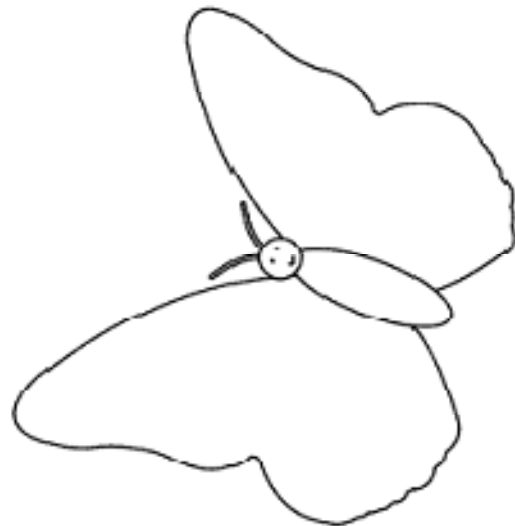
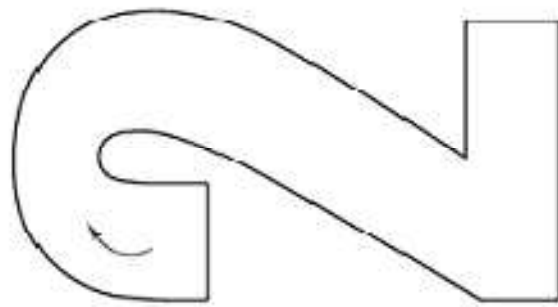

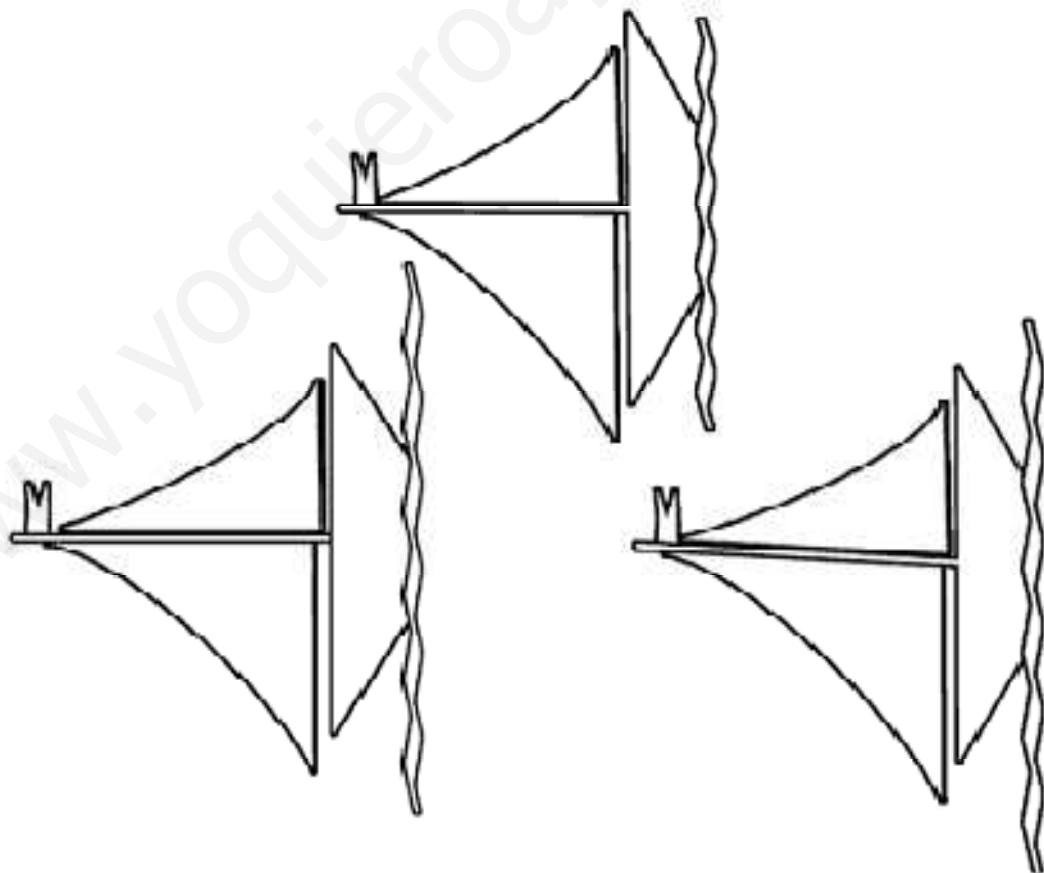
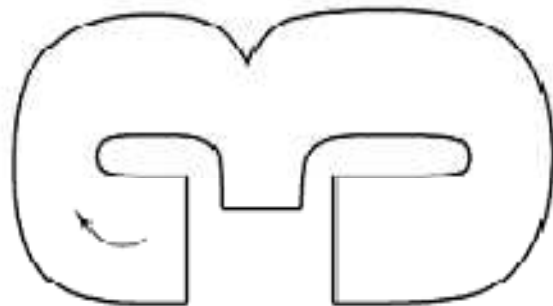

Cursc :

Nombre :

www.yoquieroaprobar.es

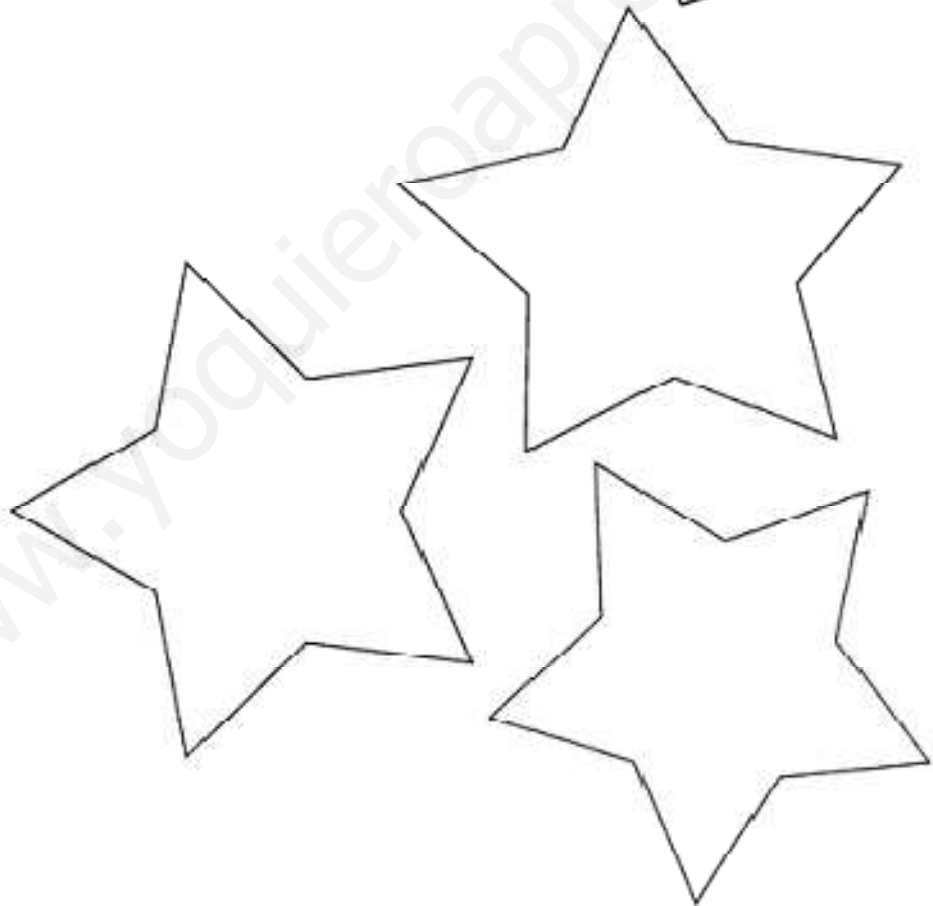
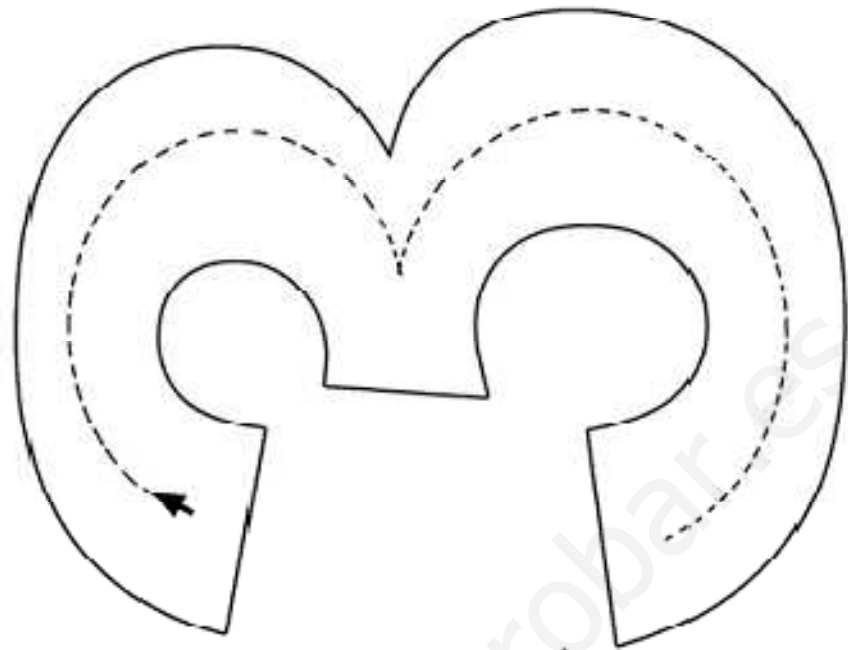

Curso :

Nombre :

Line y Colorea los Dibujos

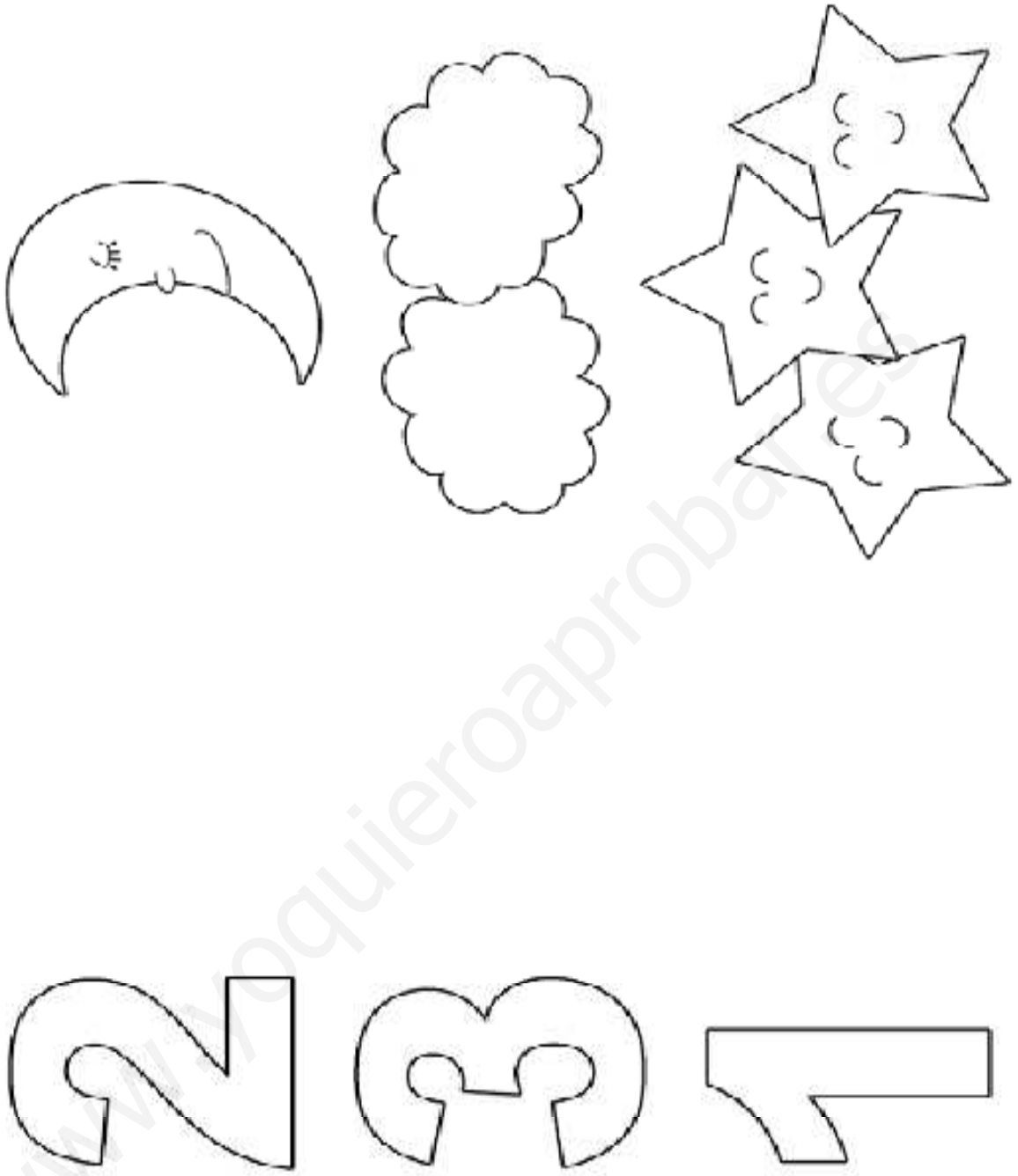

Curso :

Nombre :

Une y Colorea los Dibujos

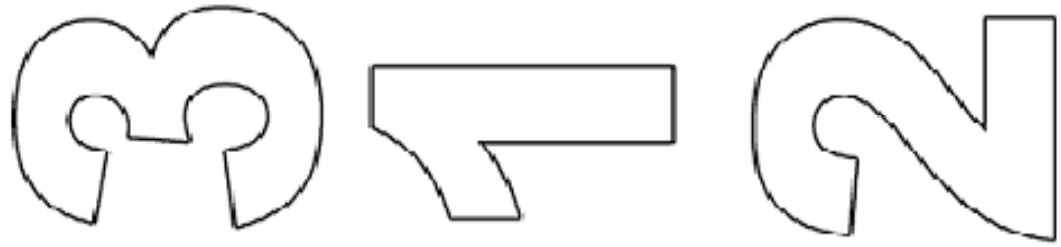

Curso :



Nombre :

GRAFO- MOTRICIDAD Y VOCALES

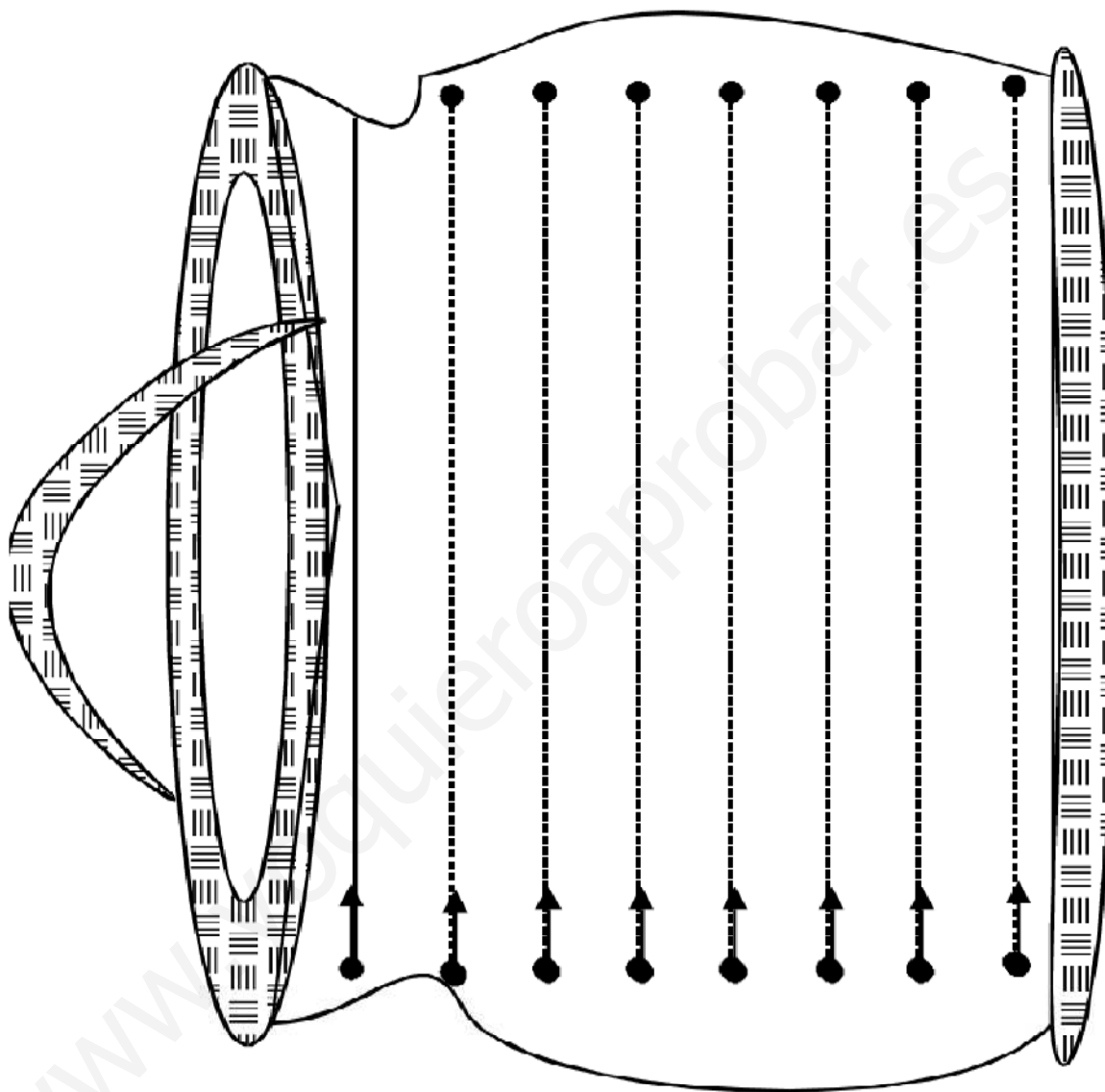

Repasa y después pica por el camino.

www.yoquieroaprobar.es

Repasa y después nica por el camino.

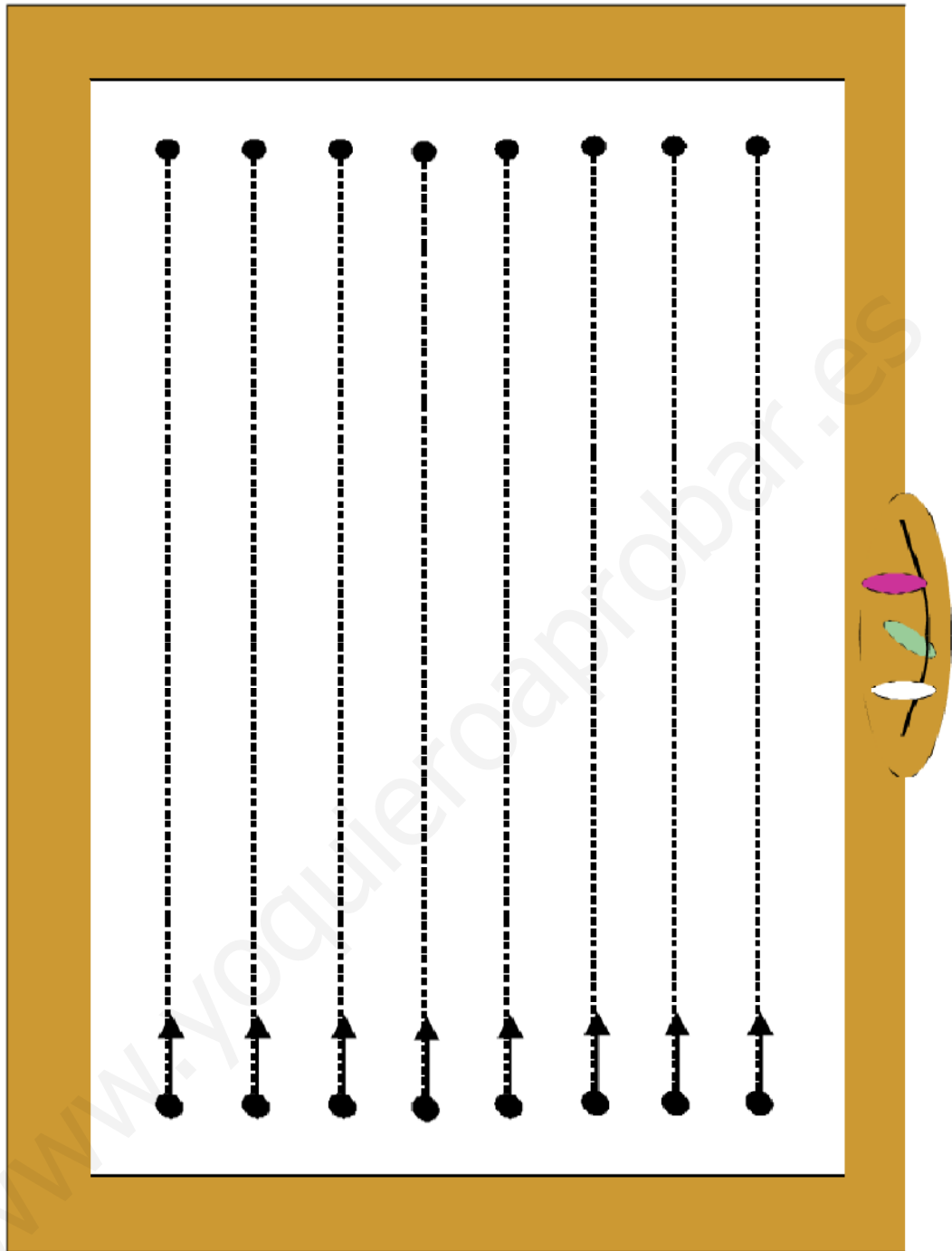

www.yoquieroaprobar.es

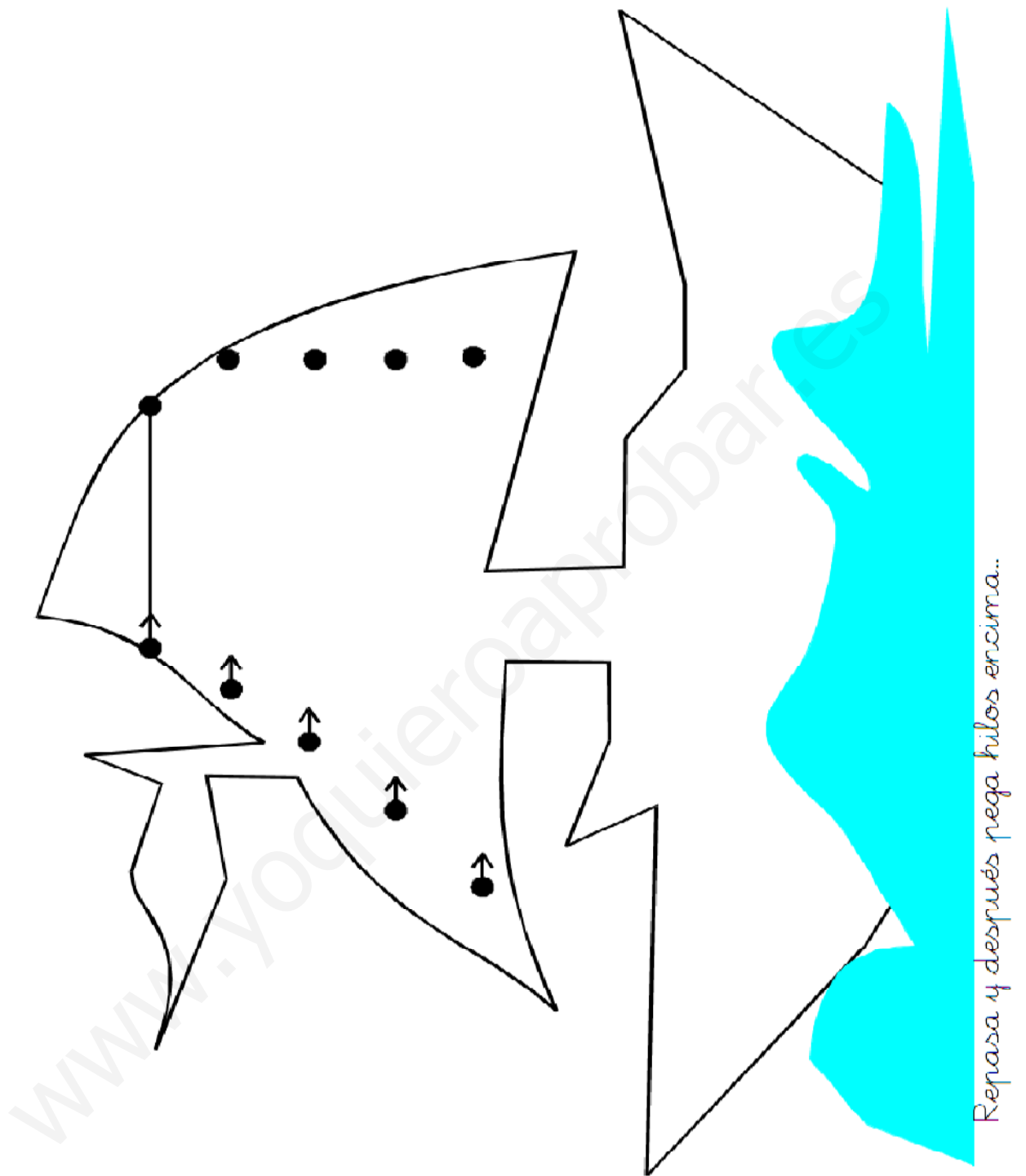

www.yoquieroaprobar.es

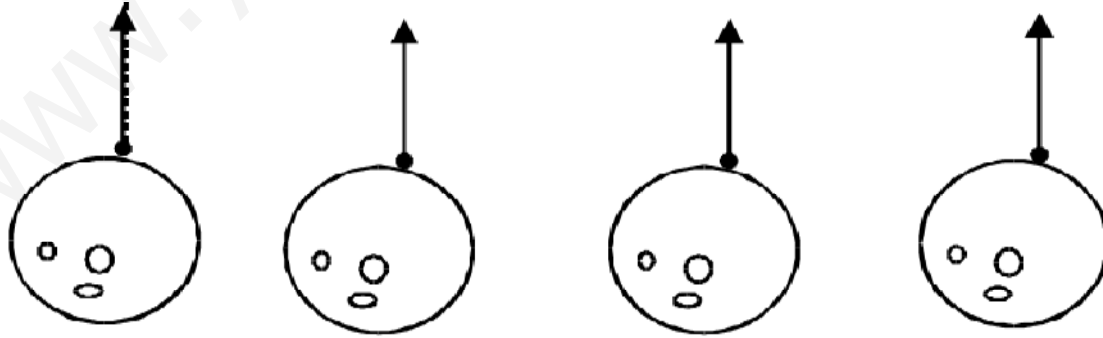
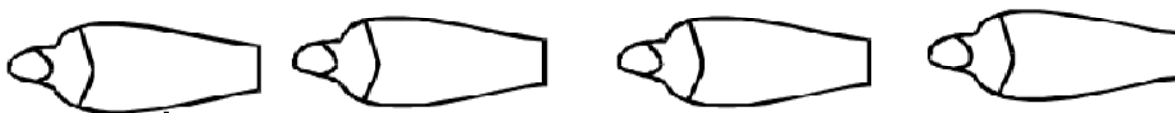

www.yoquieroaprobar.es

Repasa y pega bolitas de papel por el camino.



Repasa y reza trocitos de hoja por el camino.

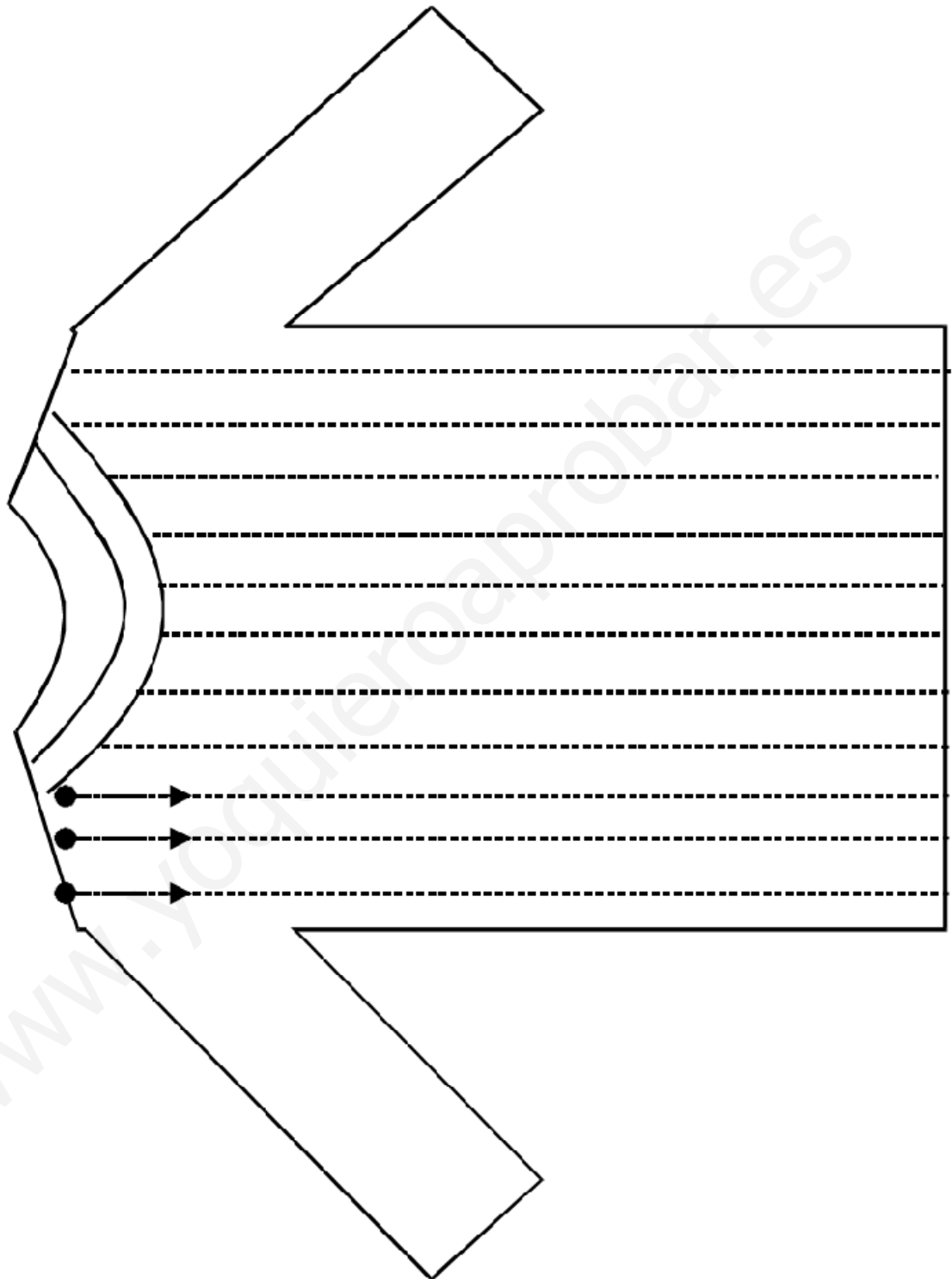

Repasa con colores y después pica sobre las líneas.

www.yoquieroaprobar.es

Haz las púas del peine y pega pabillos encima.

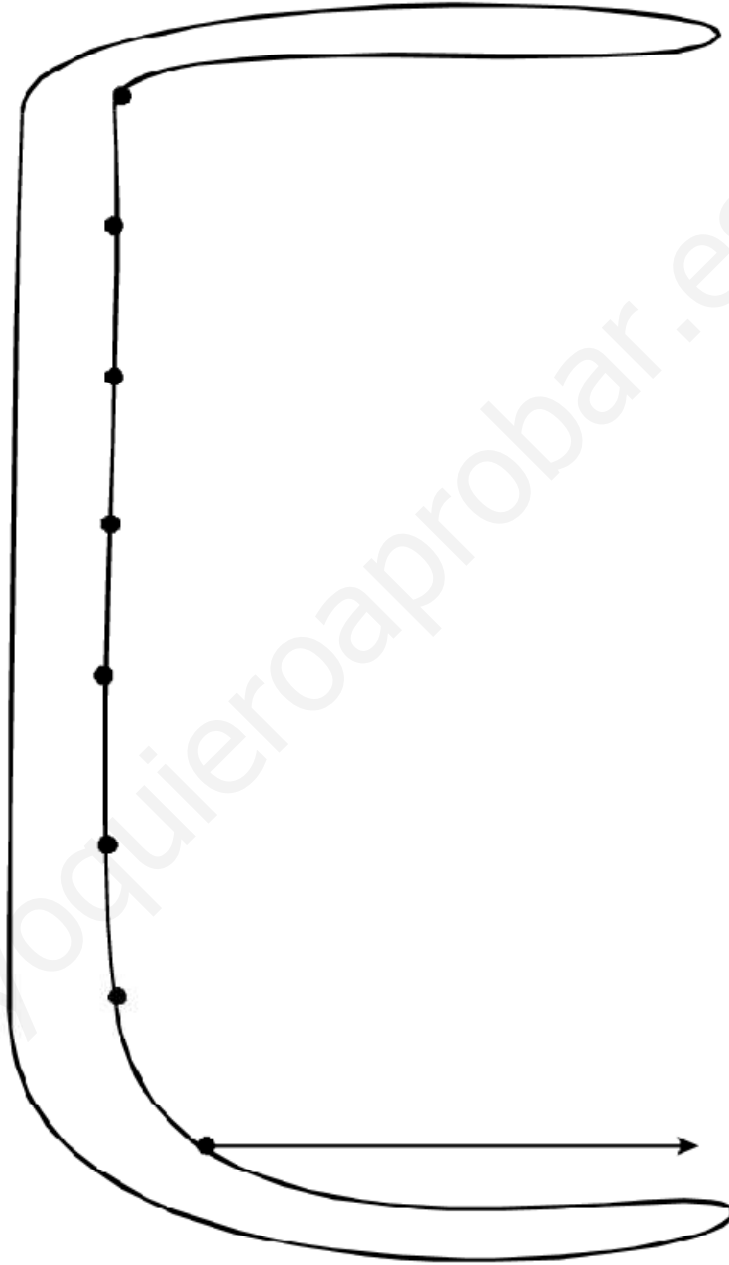

www.yoquieroaprobar.es

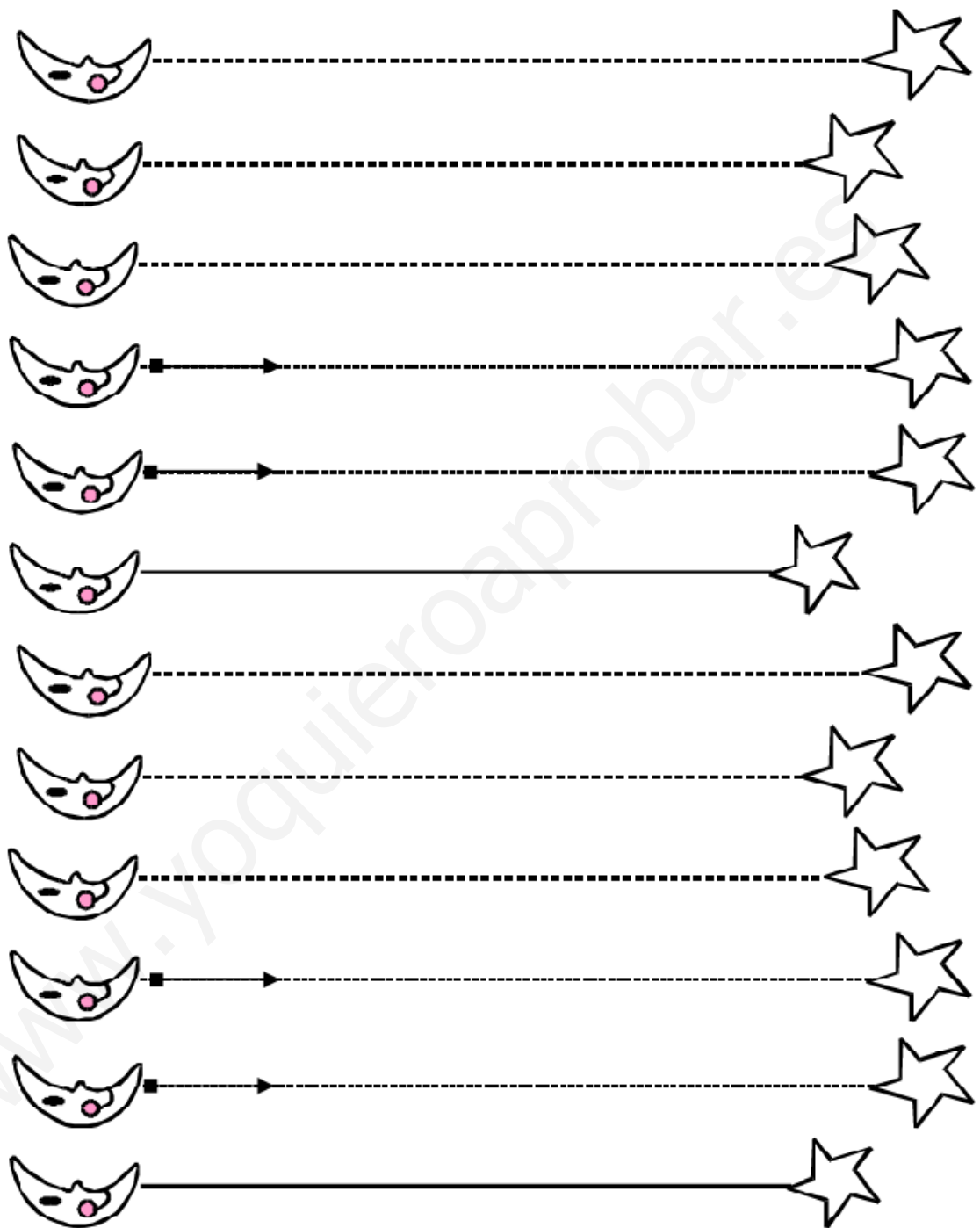

Repasa las líneas y pega lana de colores encima.

www.yoquieroaprobar.es

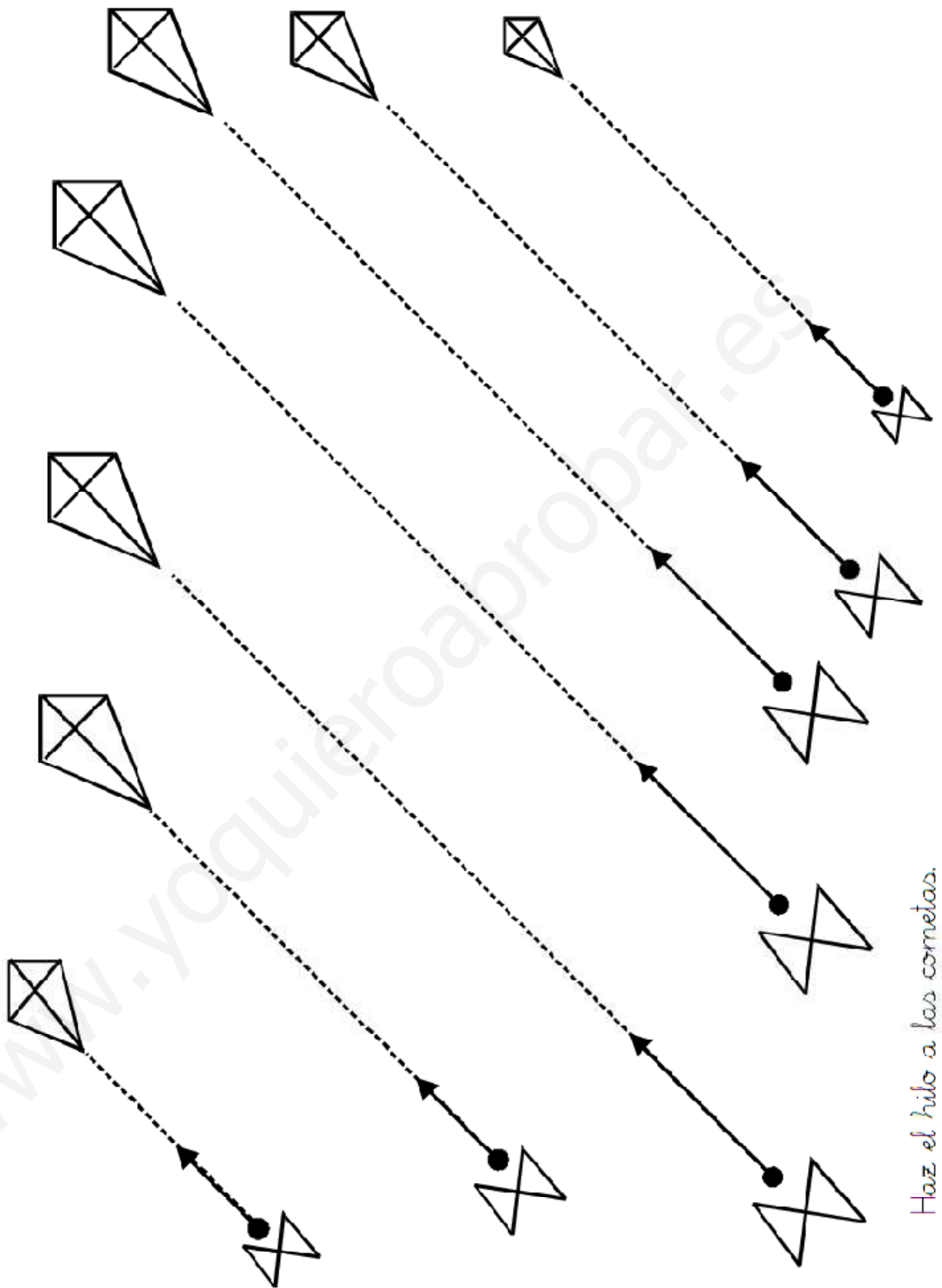

Haz el hilo a las cometas.

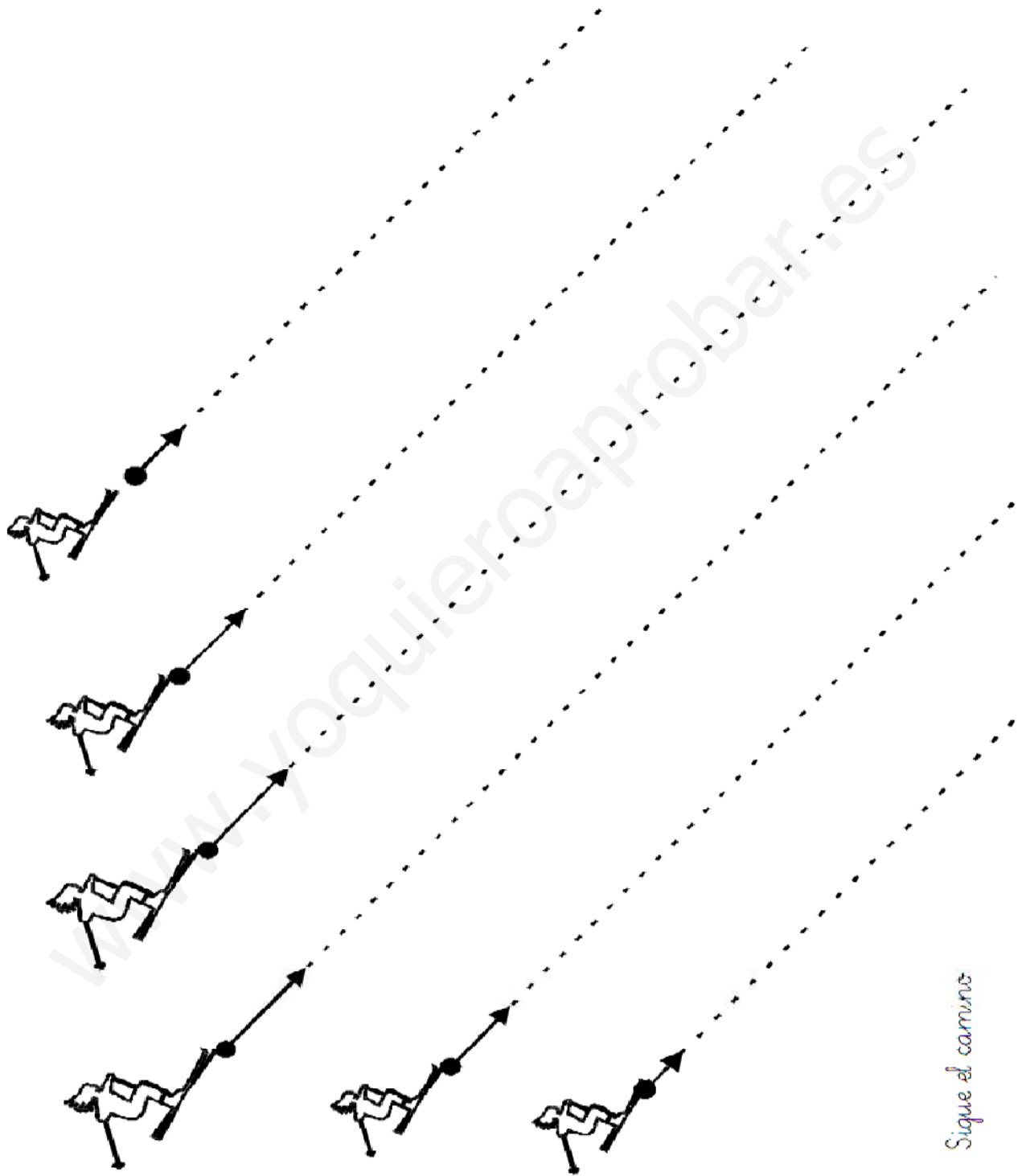

Sigue el camino

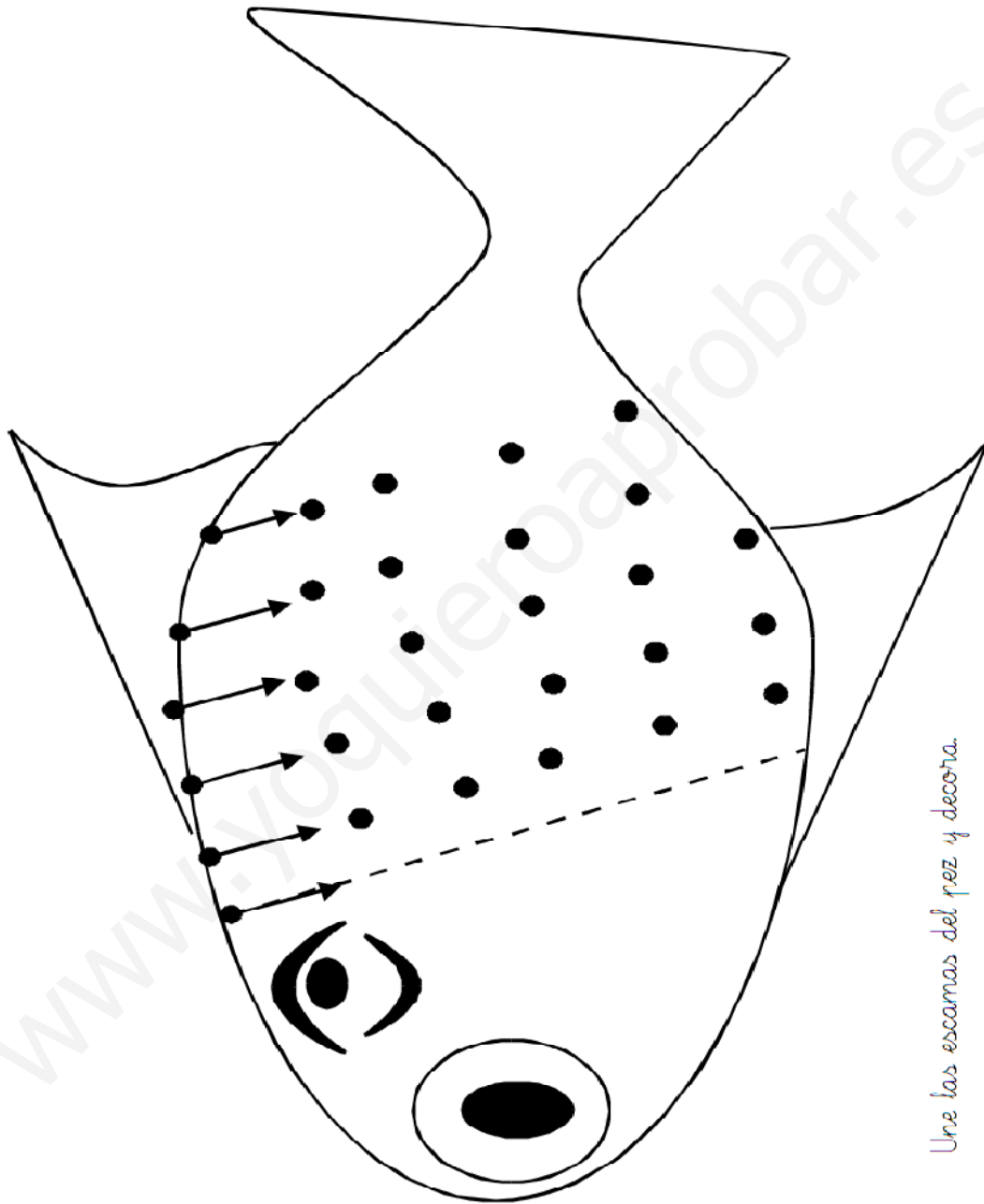

Une las escamas del pez y decóralo.

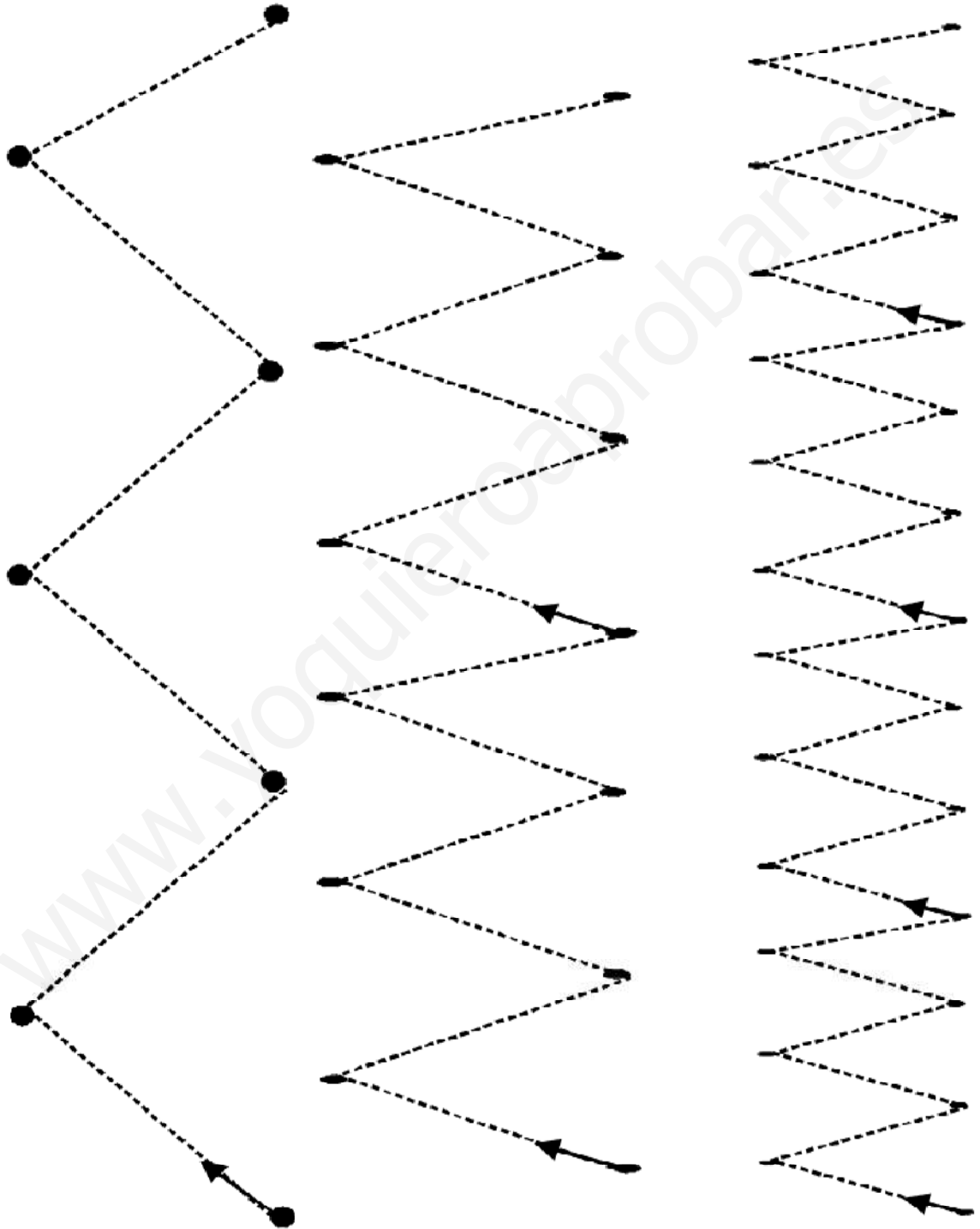

Repasa las líneas.

www.yoquieroaprobar.es

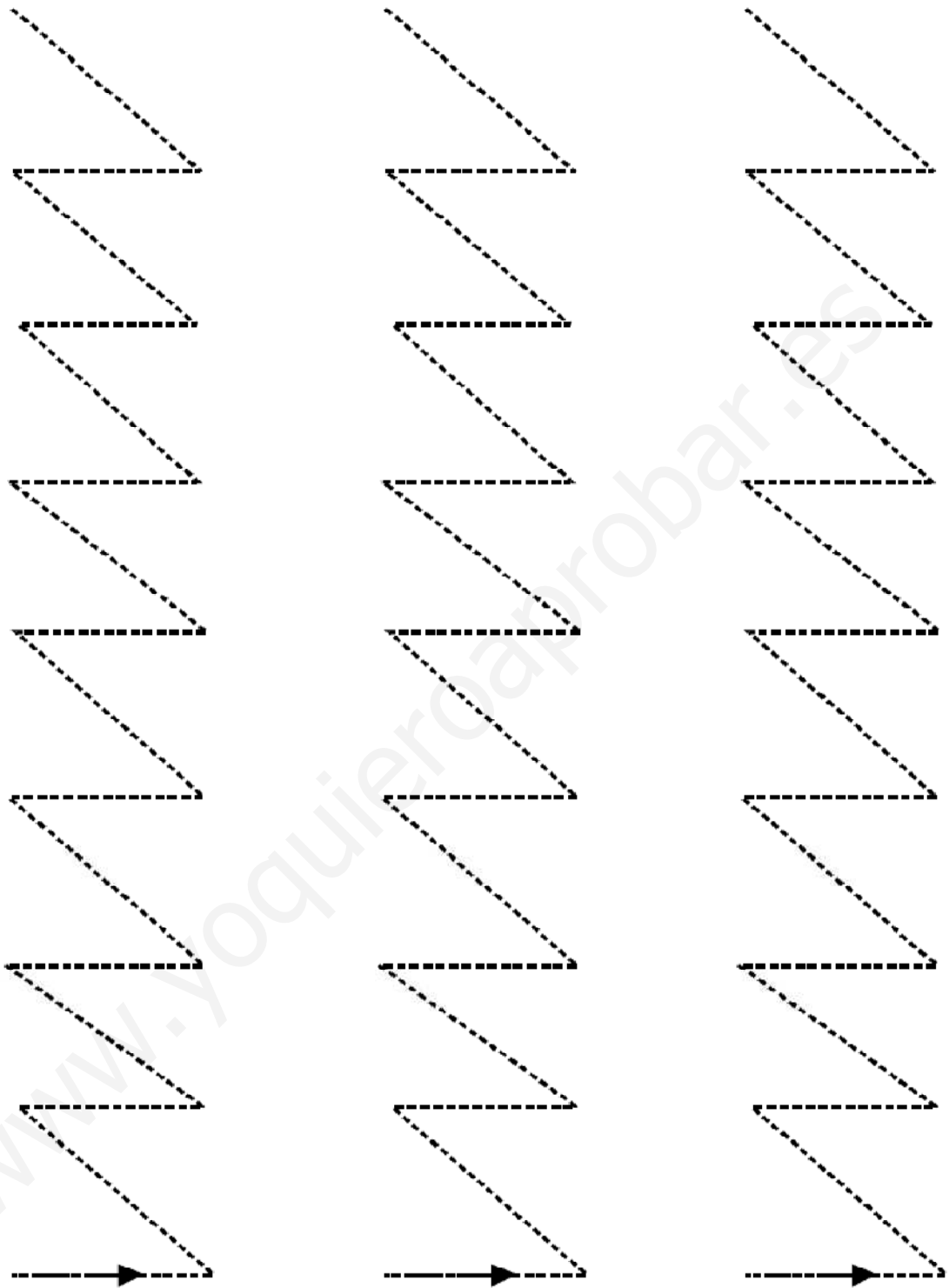

Sigue la dirección de la flecha.

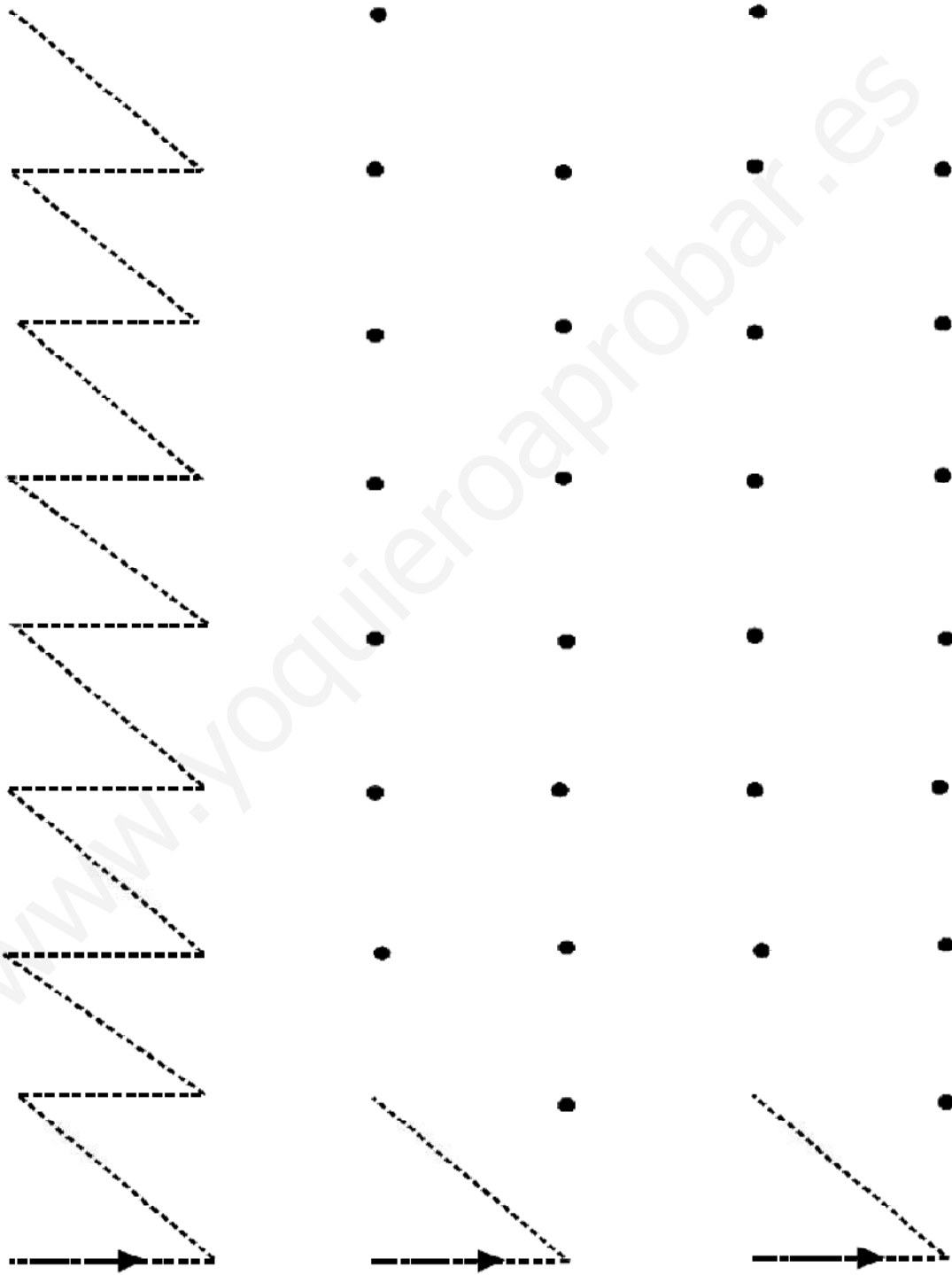

Sigue la dirección de la flecha y une los puntos.

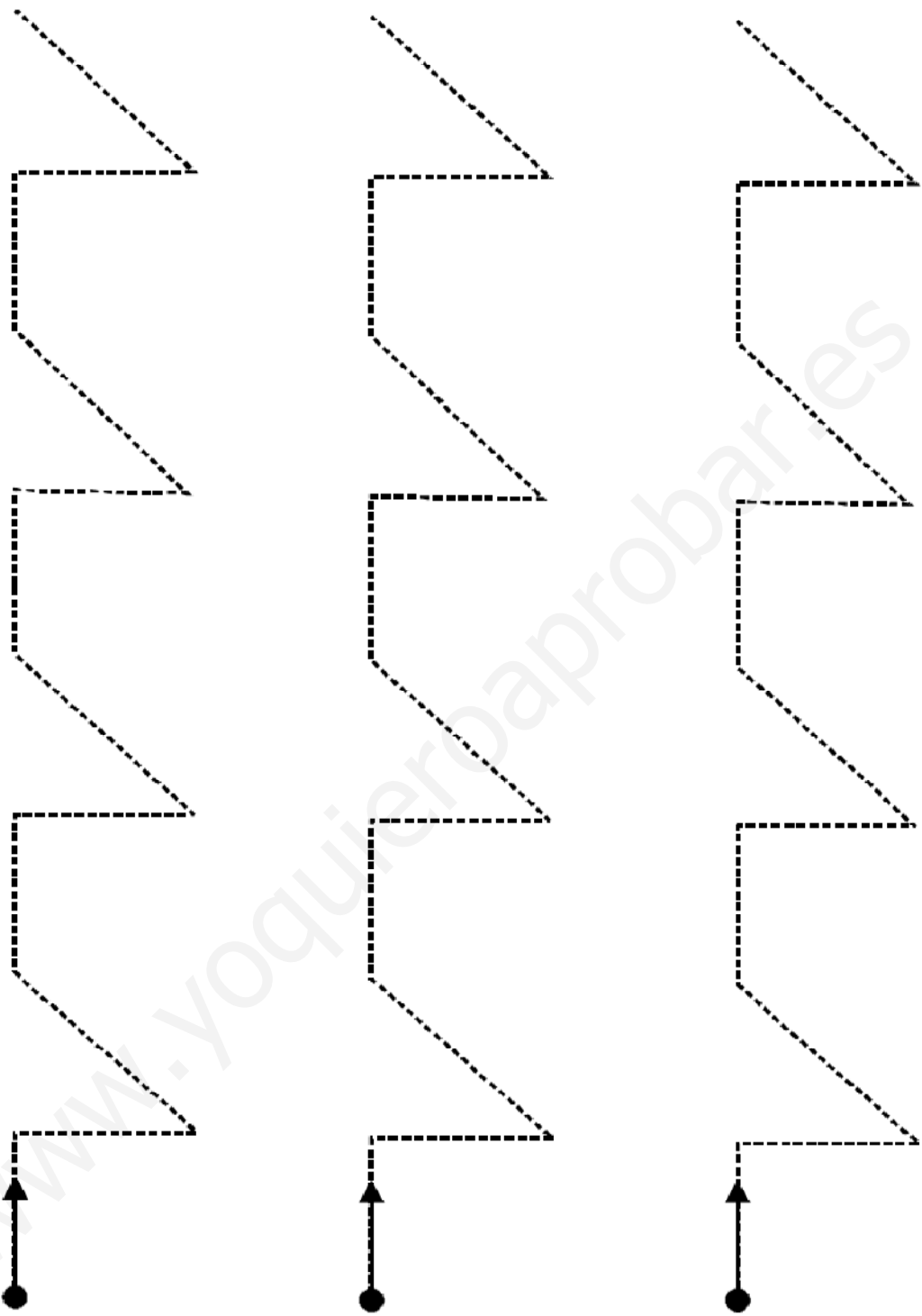

Sigue el camino.

www.yoquieroaprobar.es

Repasa y colorea.

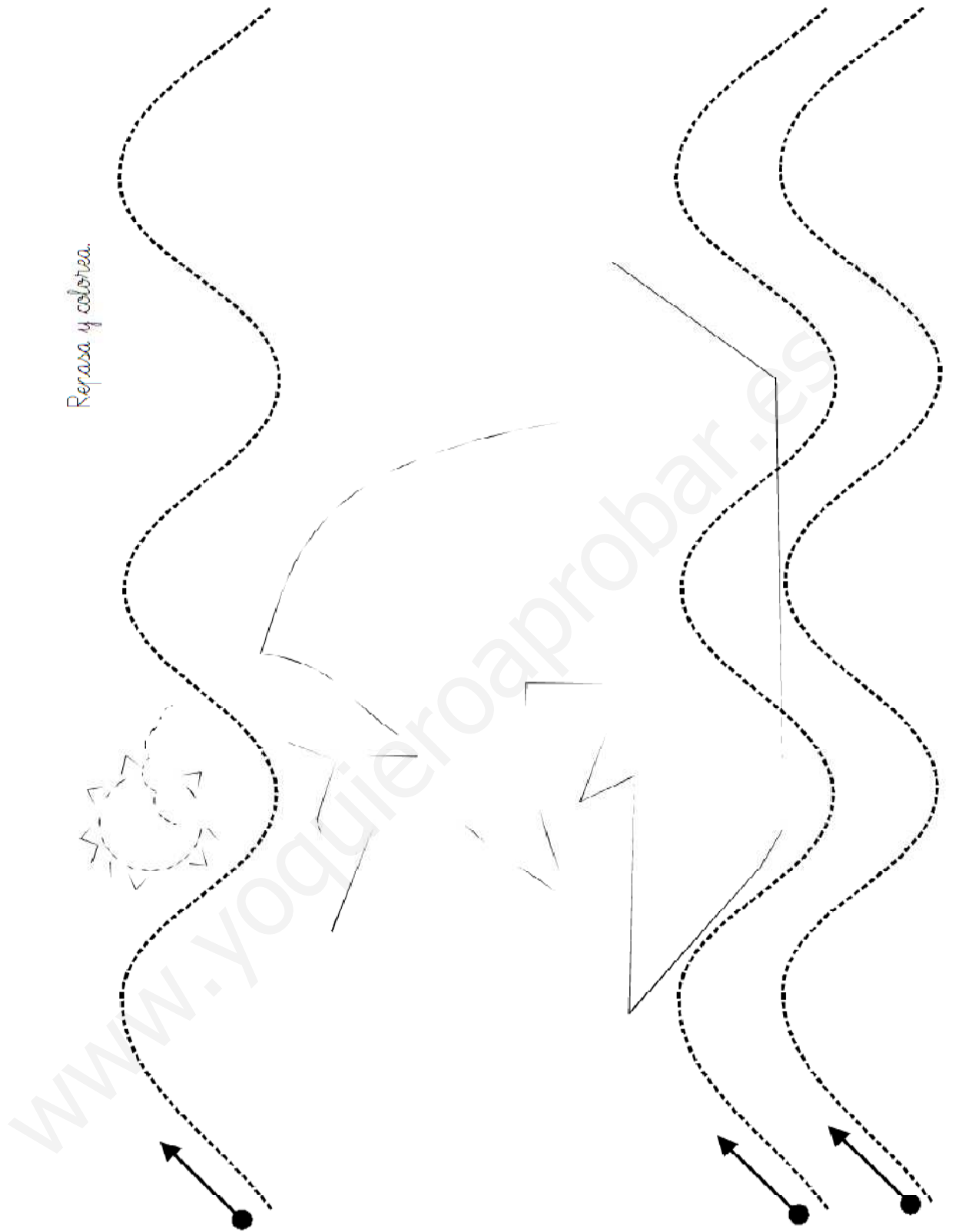

www.yoquieroaprobar.es

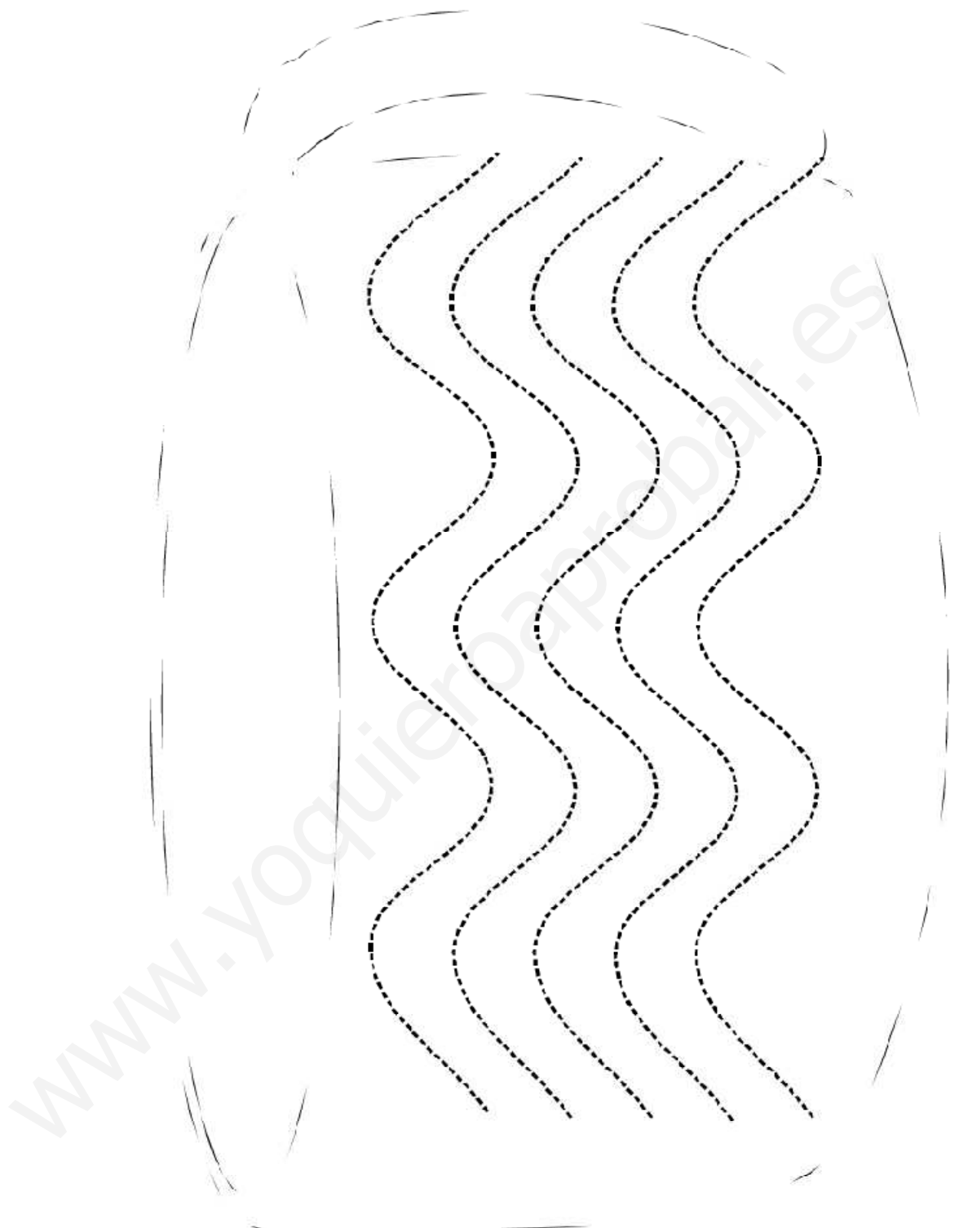

Repasa y decora.

www.yoquieroaprobar.es

Sigue el código y repasa.

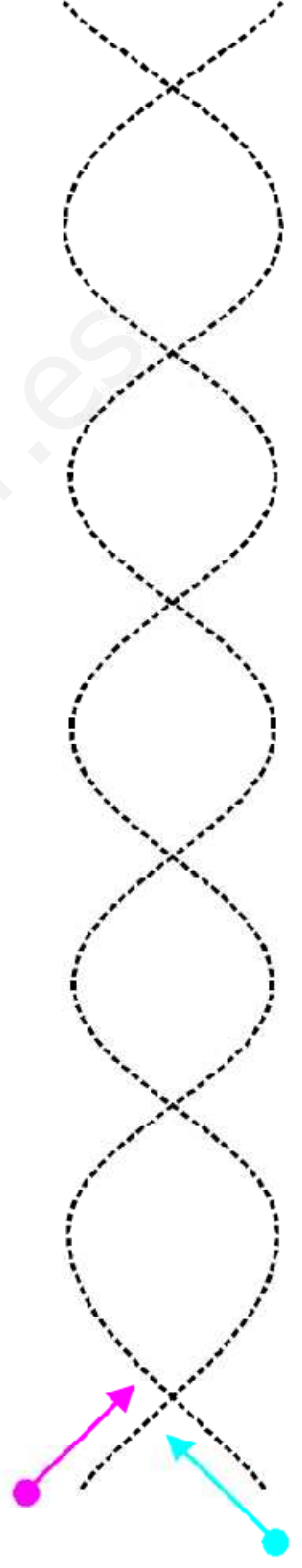
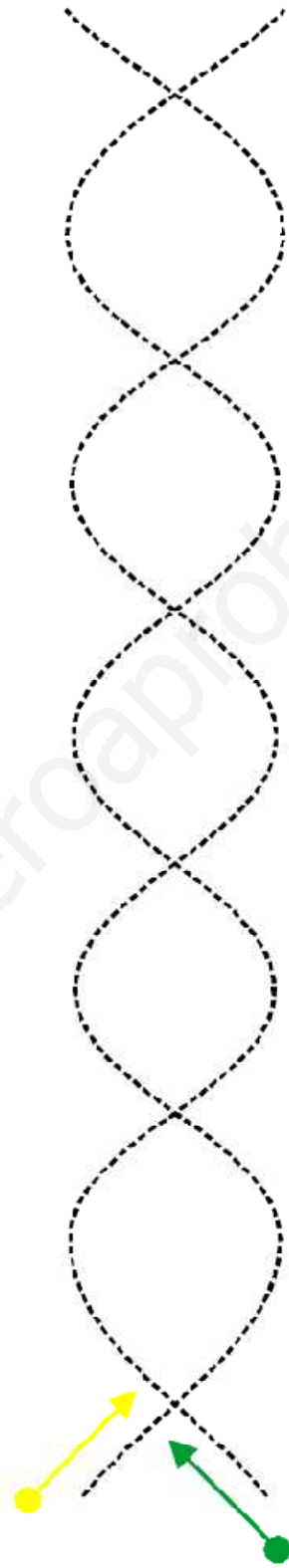
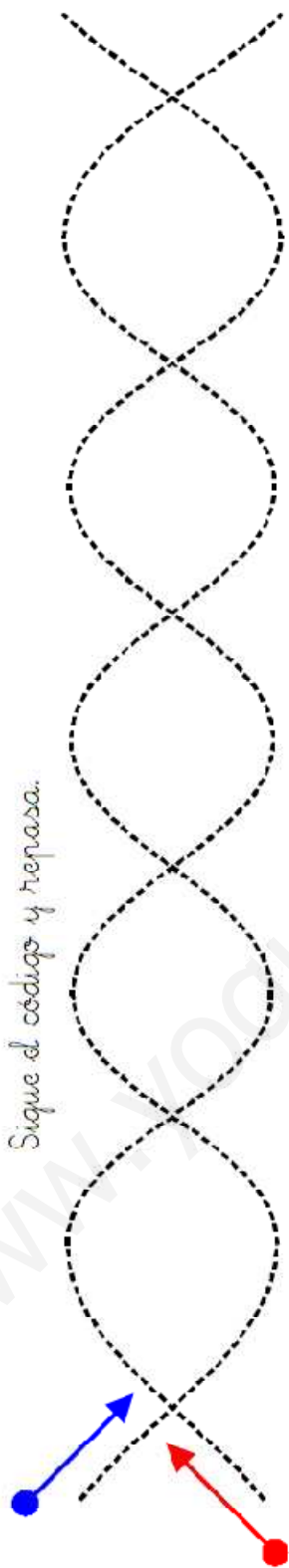

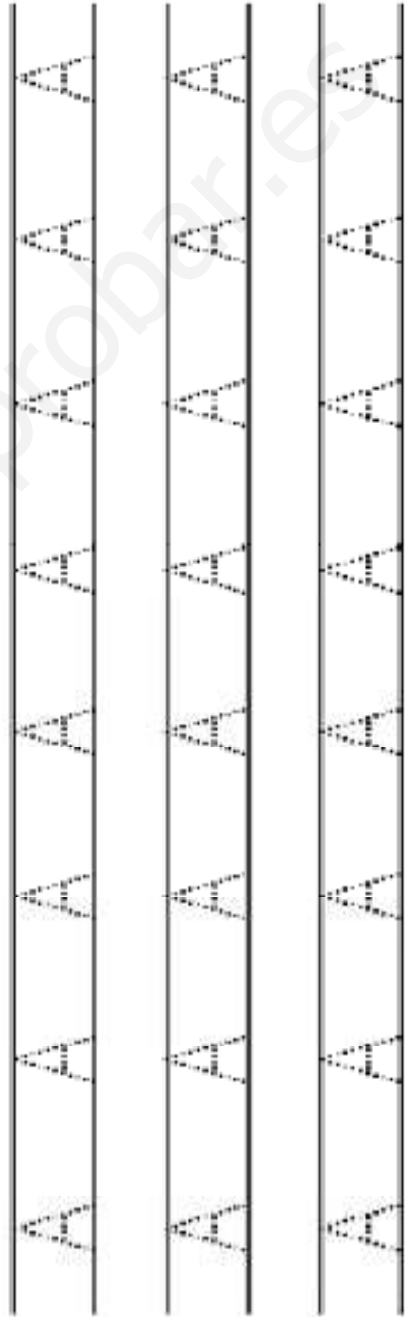
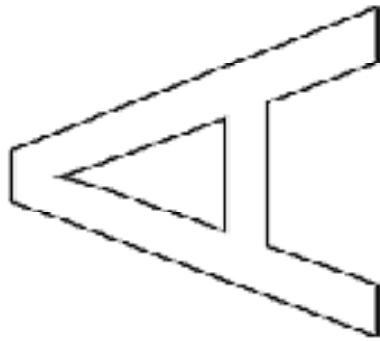
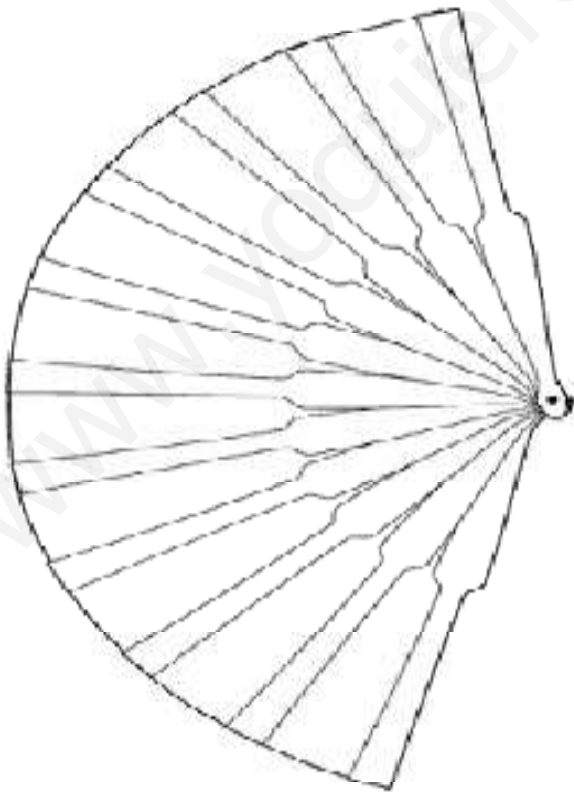

www.yoquieroaprobar.es

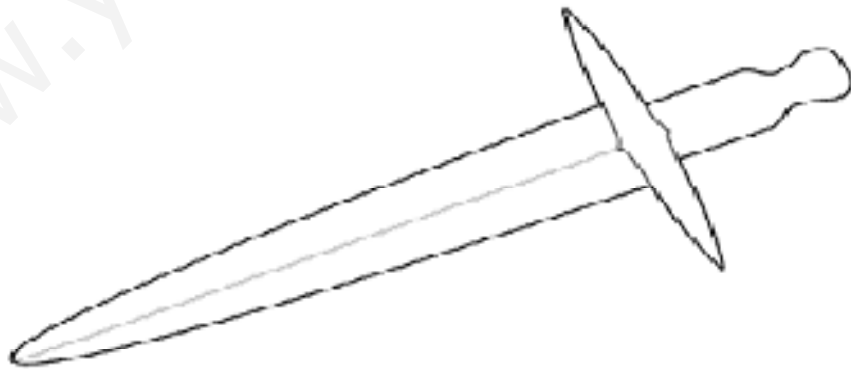
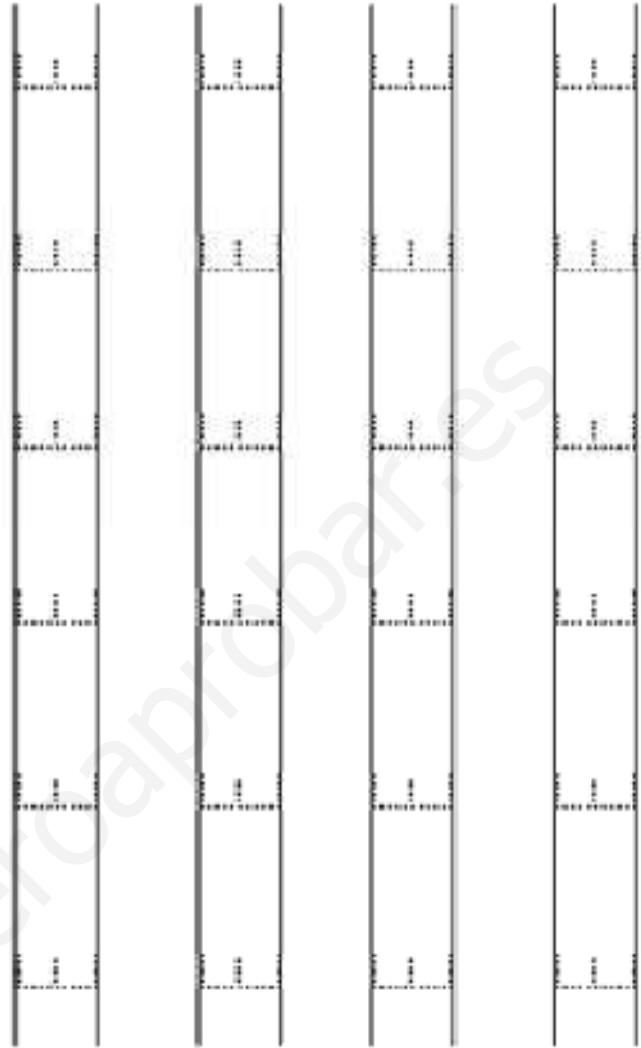
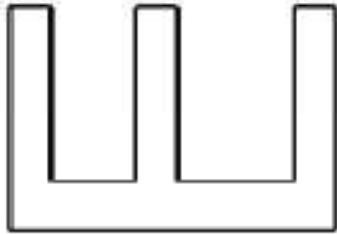

ELEFANTE

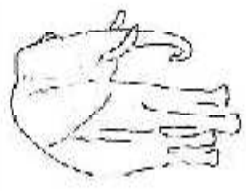

ESCALERA

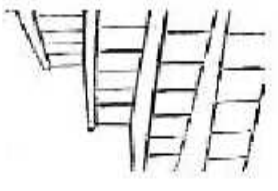

EDIFICIO

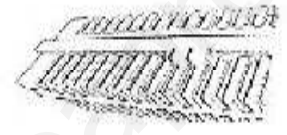

ESTRELLA

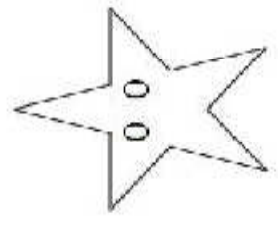

EME

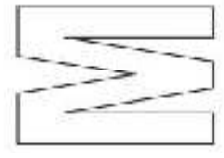

ESCOBA

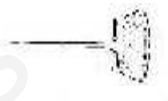

Nombre: _____
 Fecha: _____

E E E E E E E E E E E E E E E E
 E E E E E E E E E E E E E E E E
 E E E E E E E E E E E E E E E E
 E E E E E E E E E E E E E E E E
 E E E E E E E E E E E E E E E E

www.yoquieroaprobar.es

IGLÚ



IGLESIA



ICEBERG



INDIO

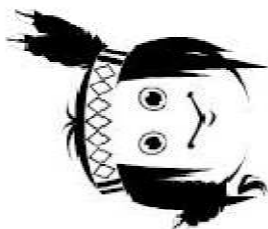

ISLA



INÉS



Nombre: _____

Fecha: _____

.....
.....
.....
.....
.....
.....
.....
.....
.....
.....

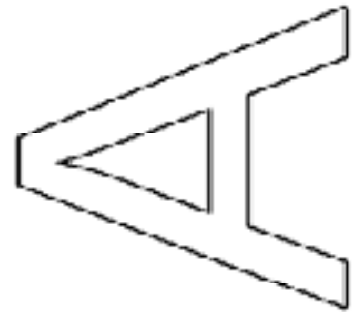
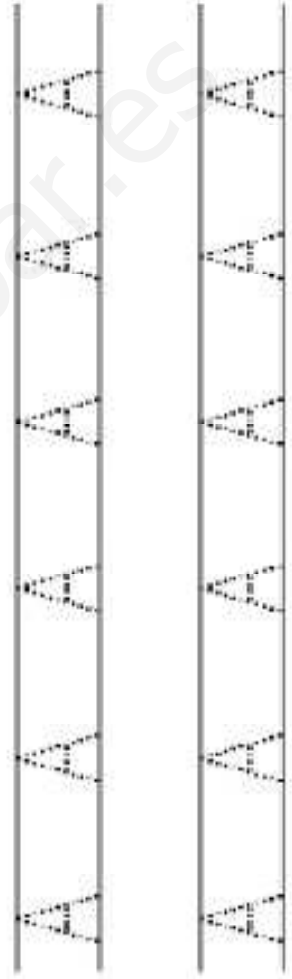
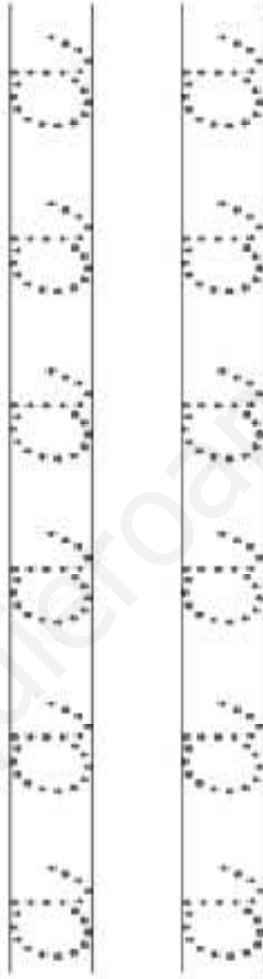
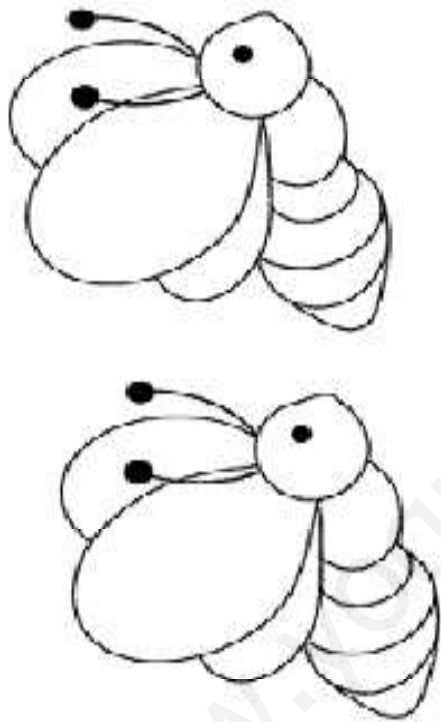

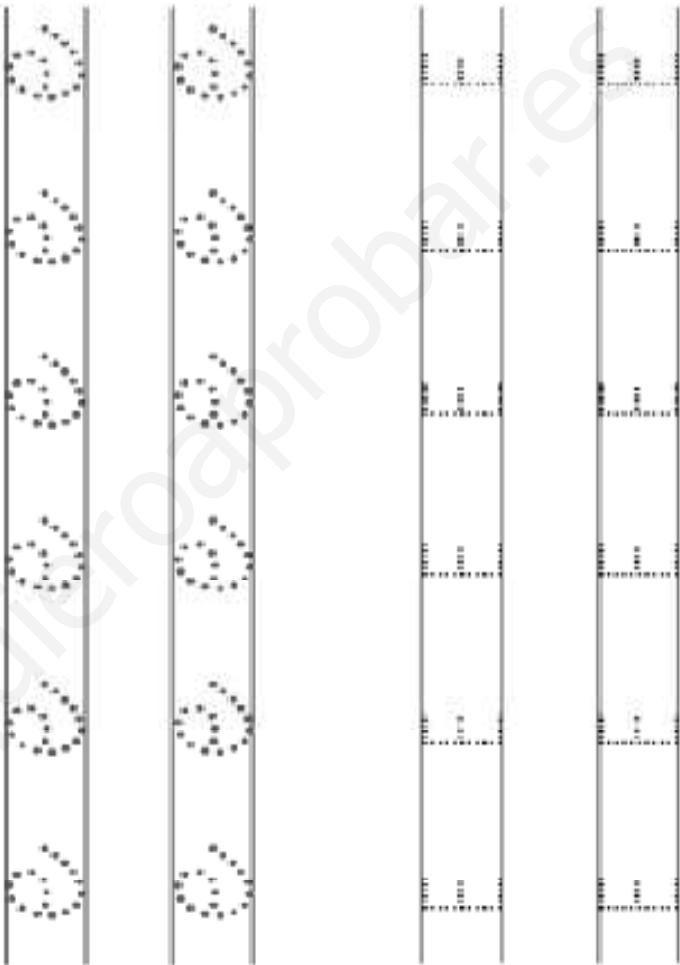
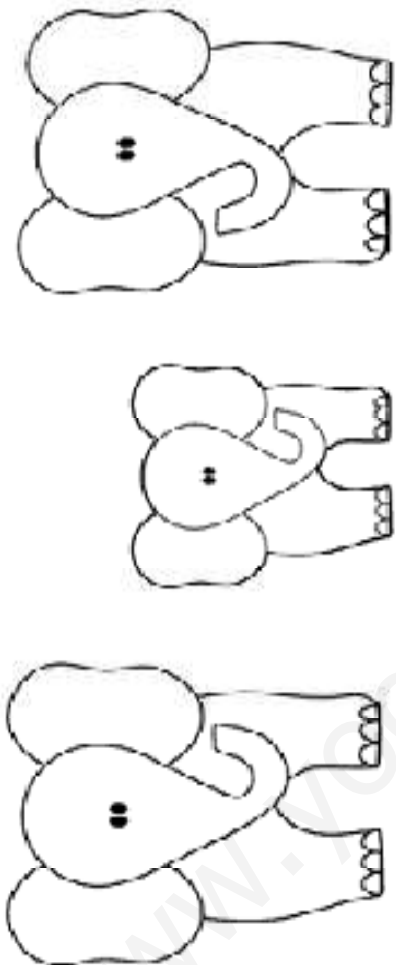

Curso :

Nombre :

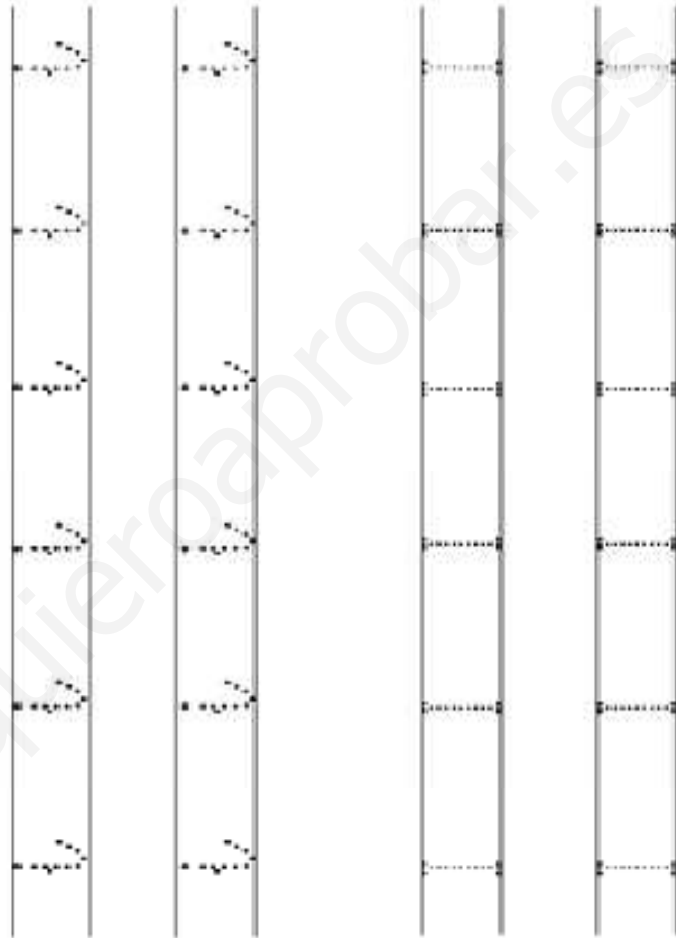
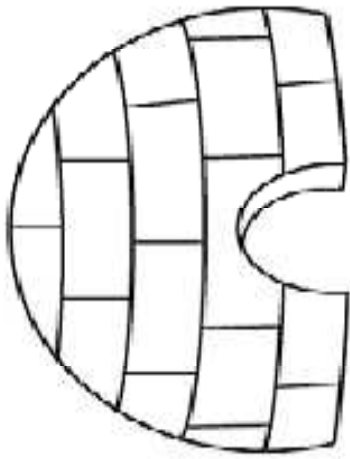

Curso :

Nombre :

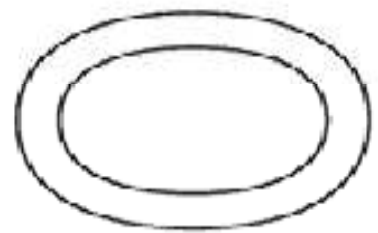
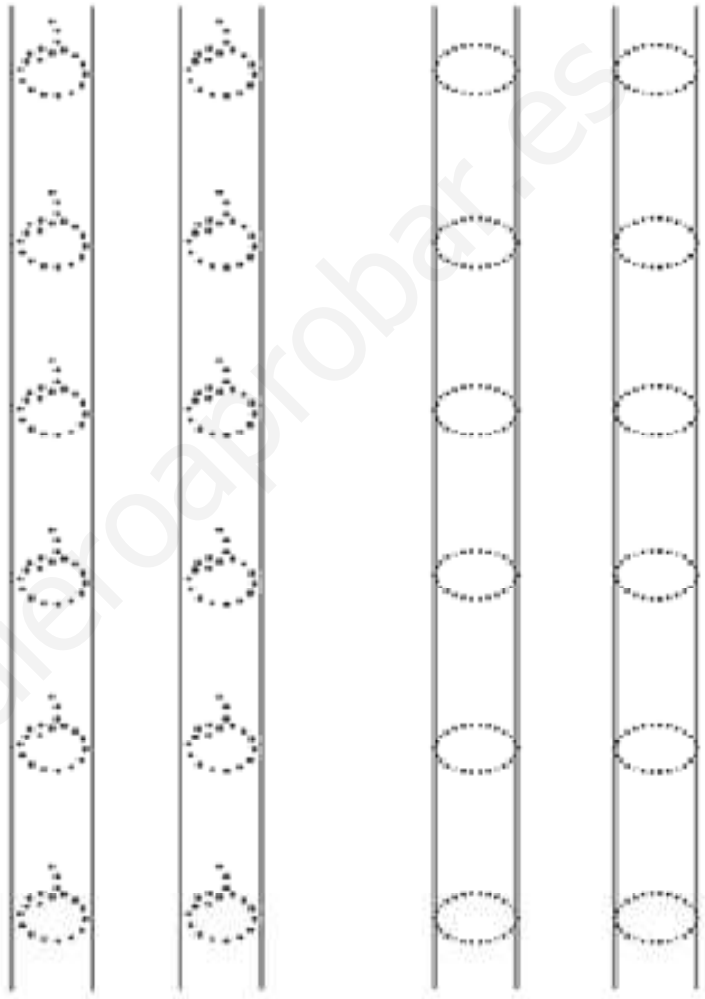

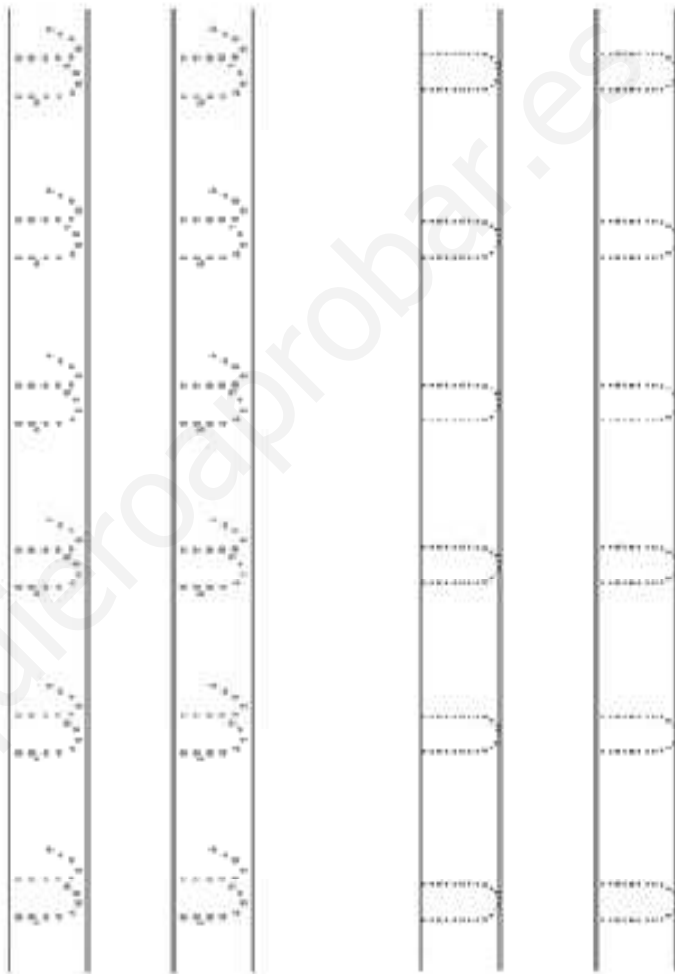
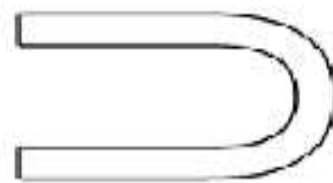
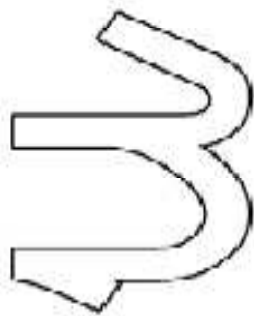

Nombre :

Curso :

PUZZLES DE ANIMALES

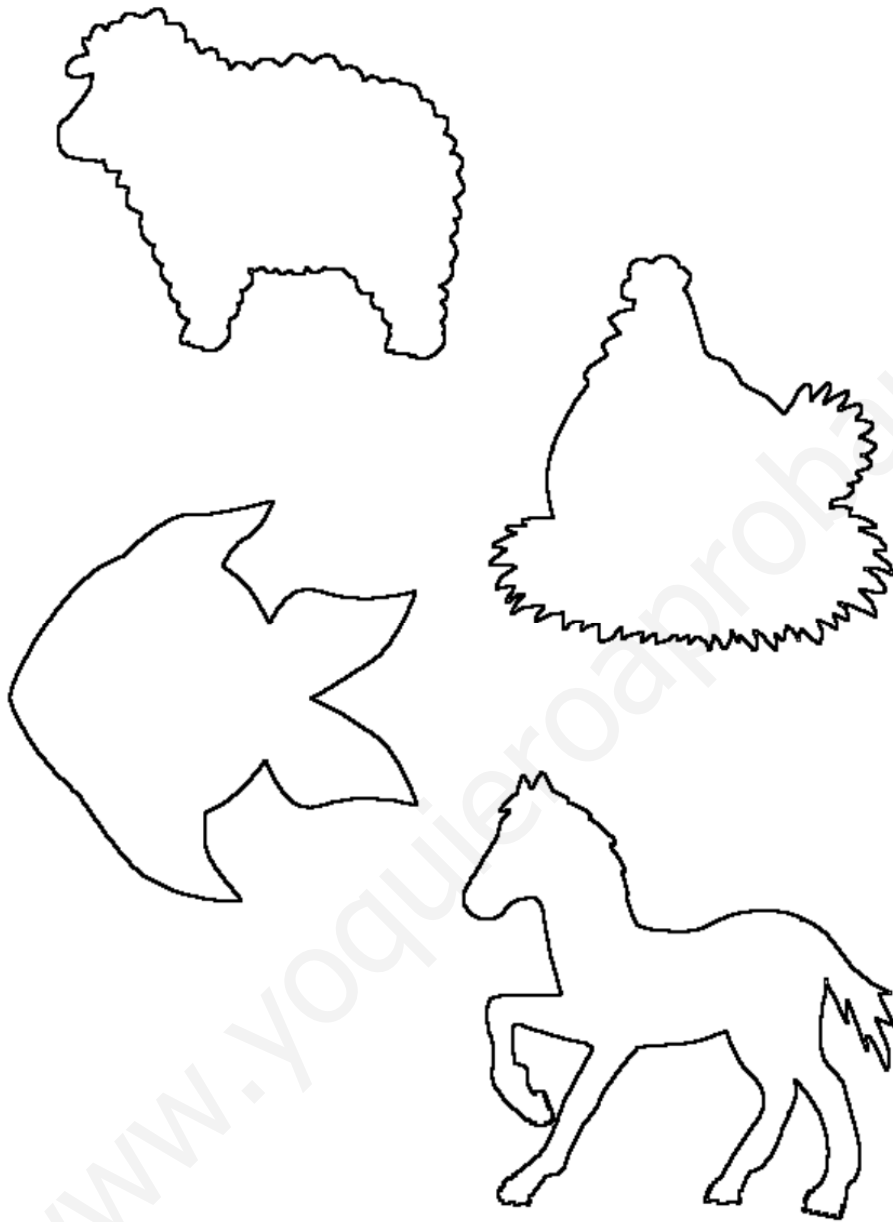

www.yoquieroaprobar.es

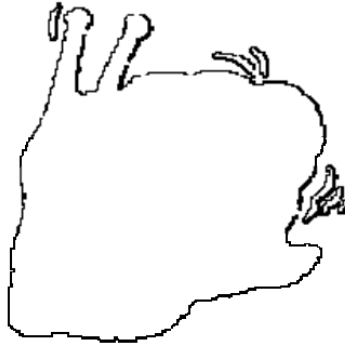
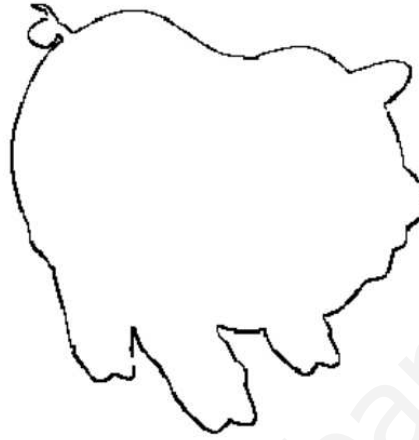
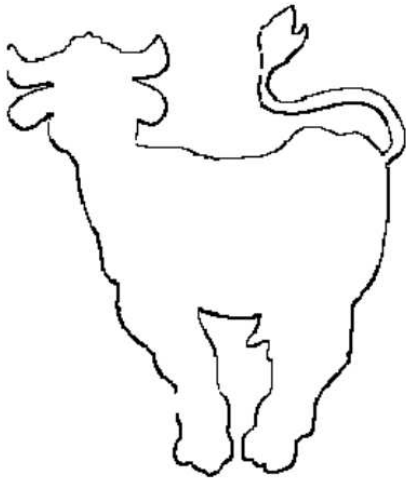

www.yoquieroaprobar.es



www.yoquieroaprobar.es



www.yoquieroaprobar.es

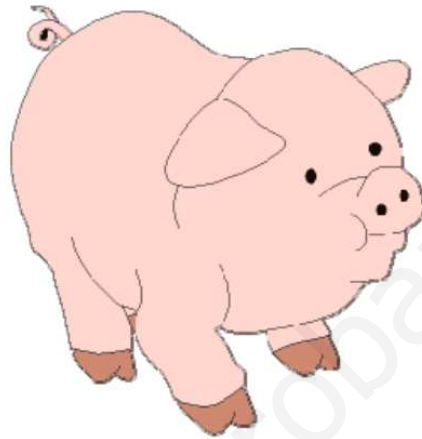
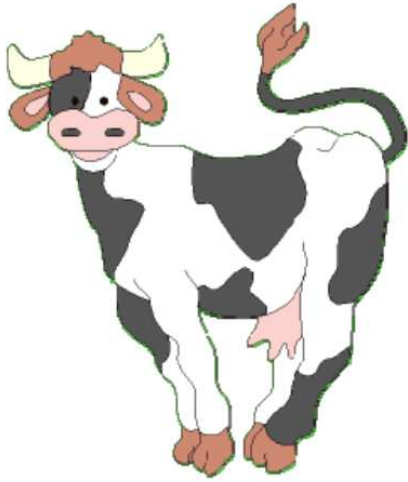

www.yoquieroaprobar.es



www.yoquieroaprobar.es

CONCEPTOS

¿Qué tenemos dentro de casa?

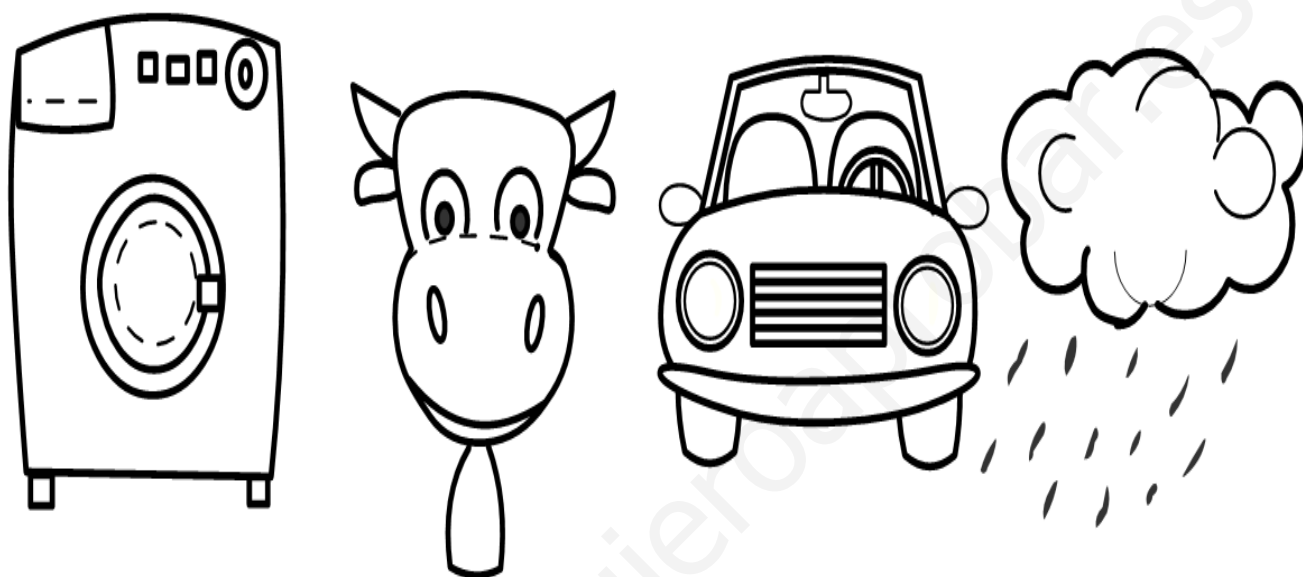

¿Qué encontramos fuera de casa?

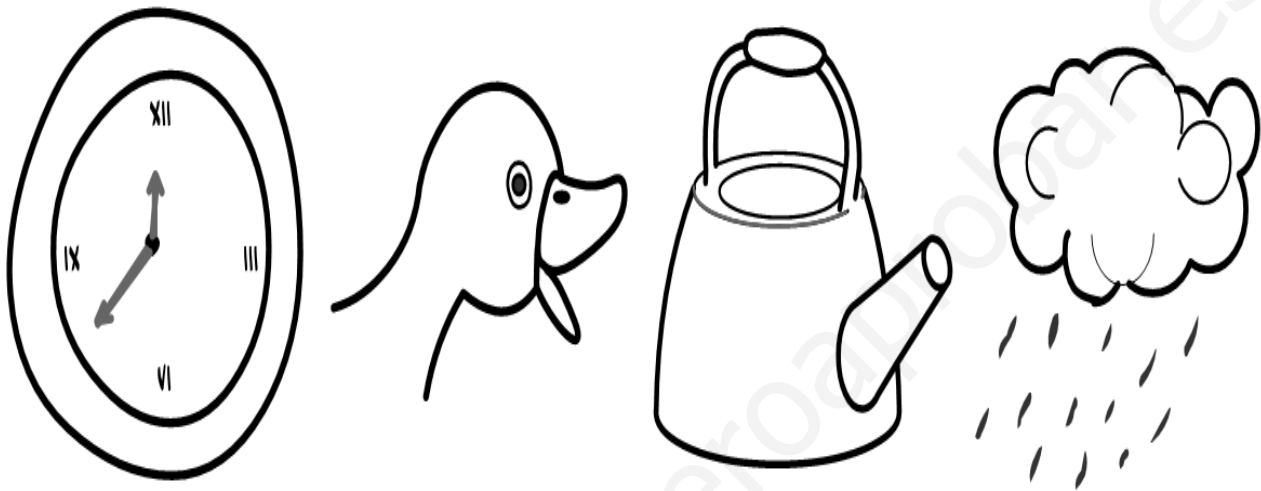

COLOREA EL MÁS LENTO

RÁPIDO - LENTO

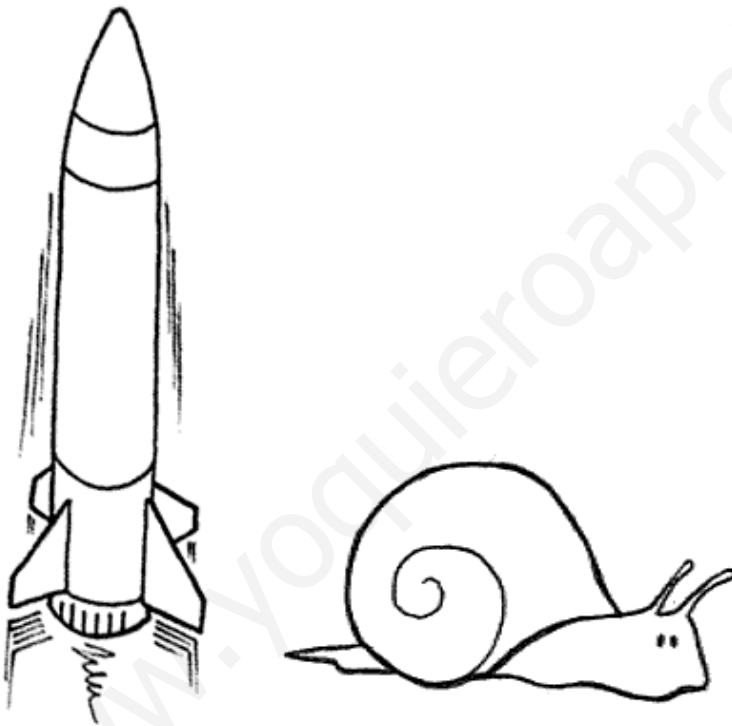

RODEA EL VASO VACÍO

LLENO - VACÍO

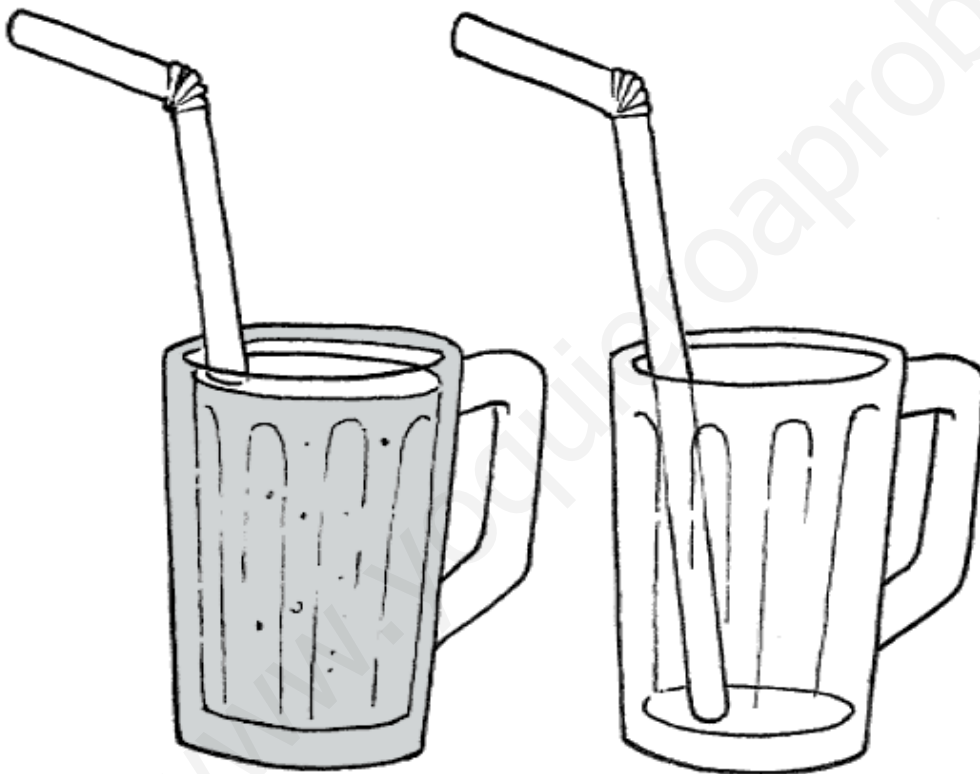

LLENO / VACÍO : Colorea la botella que está llena

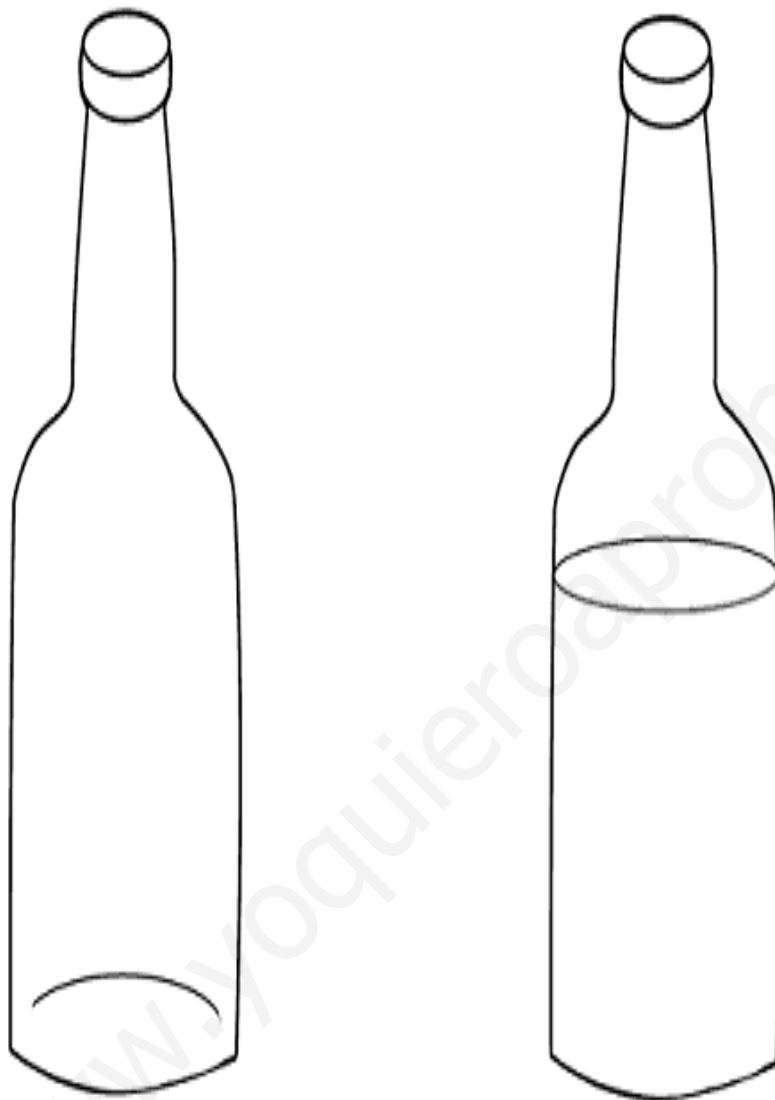

Colorea la Manzana GRANDE

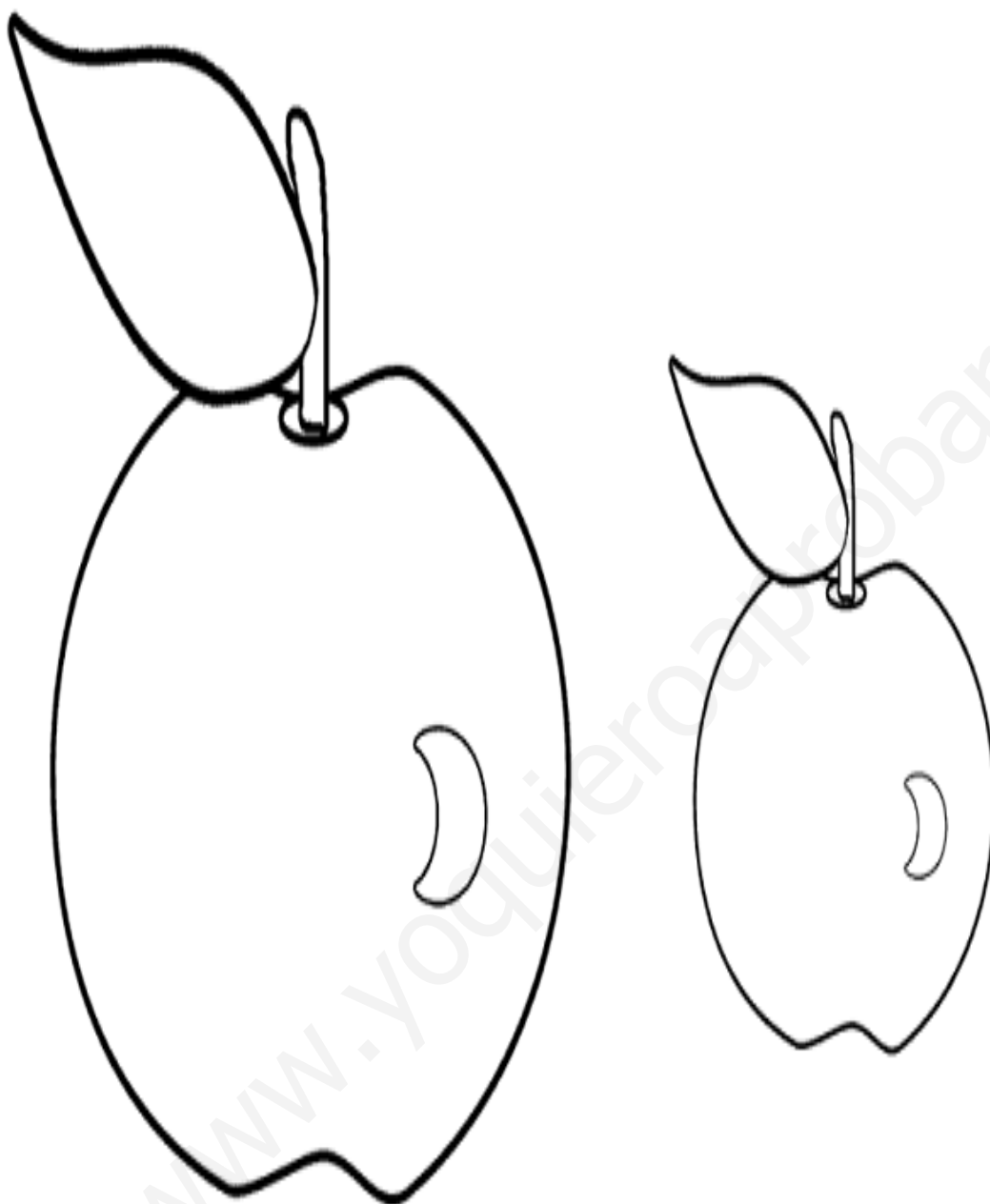

LLENO / VACÍO : Colorea la Pecera que está LLENA

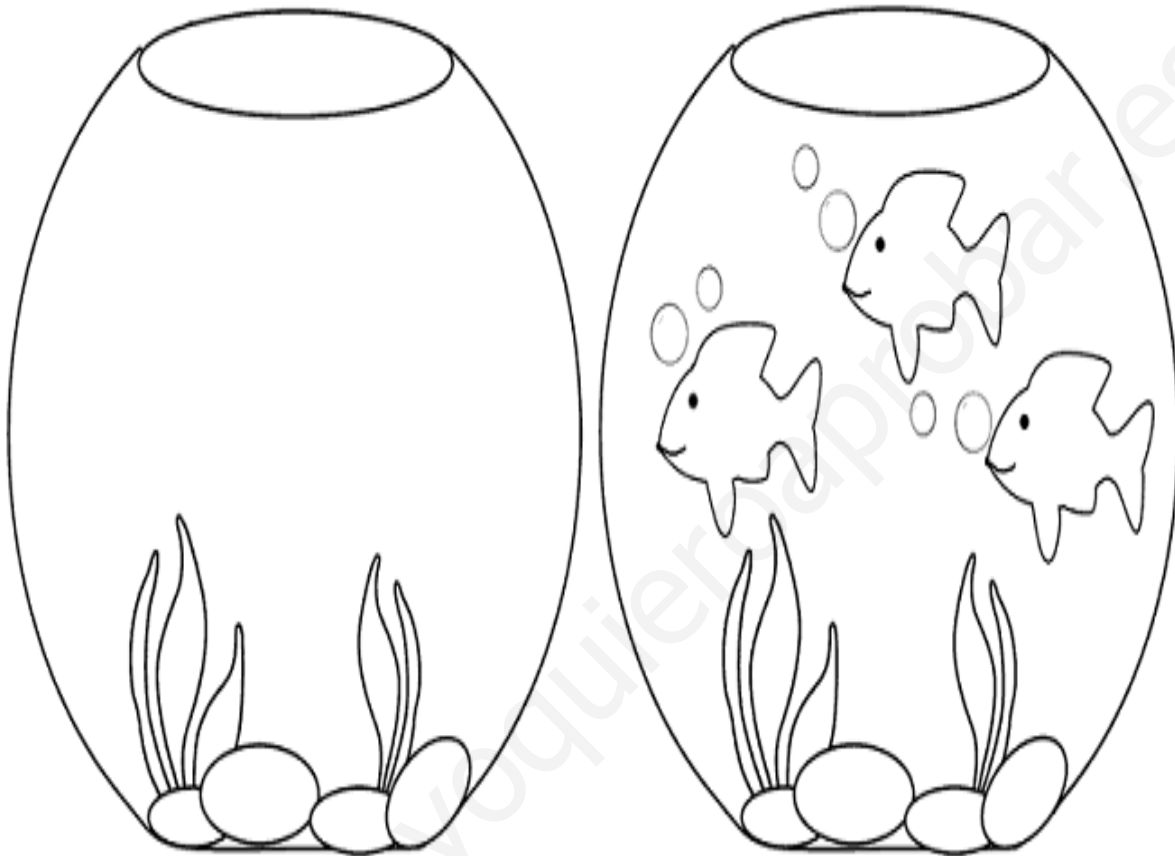

ENCIMA / DEBAJO : Colorea las gallinas que hay debajo

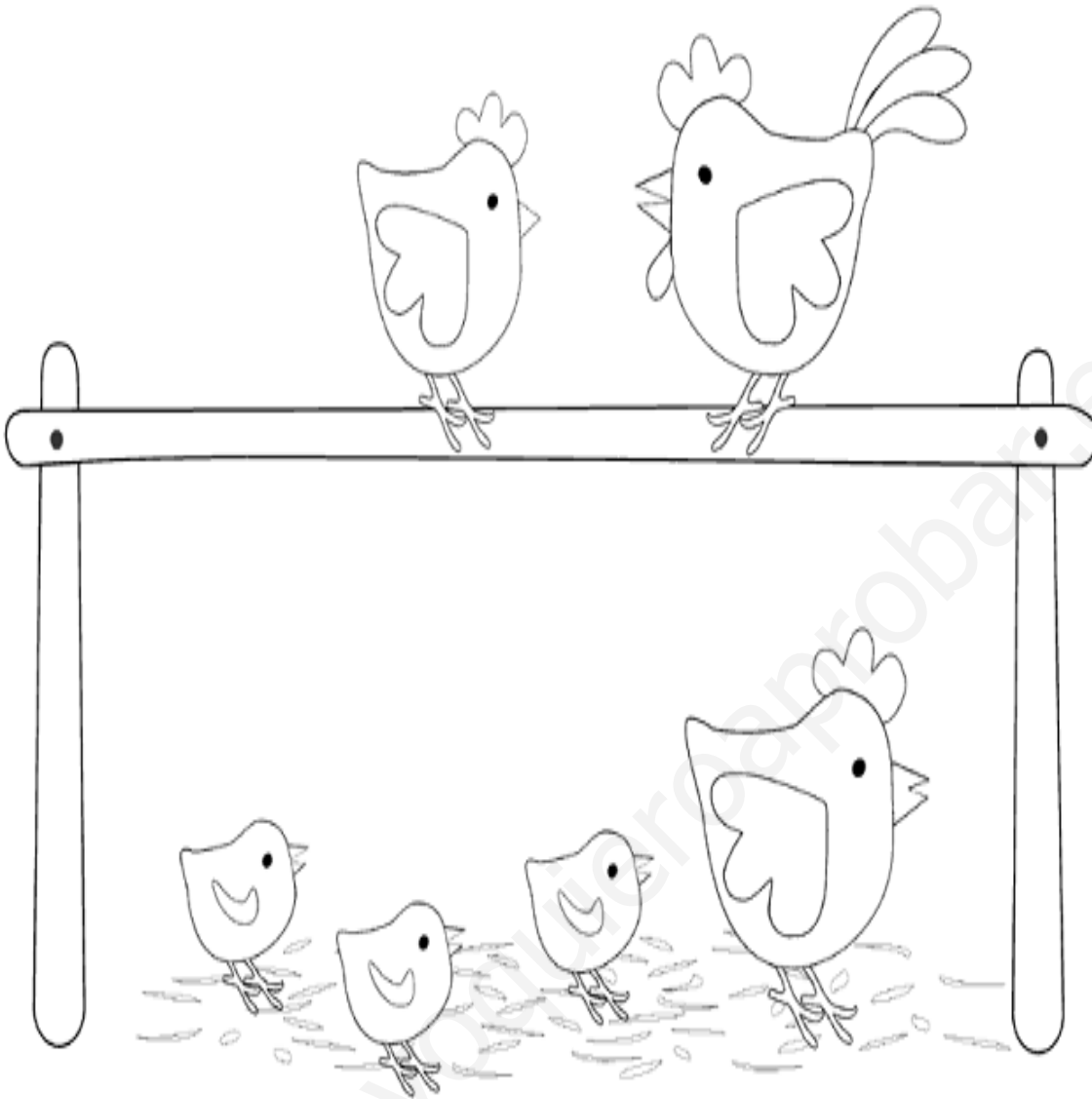

GRANDE / MEDIANO / PEQUEÑO : Colorea el gallo Grande y rodea con un círculo el mediano

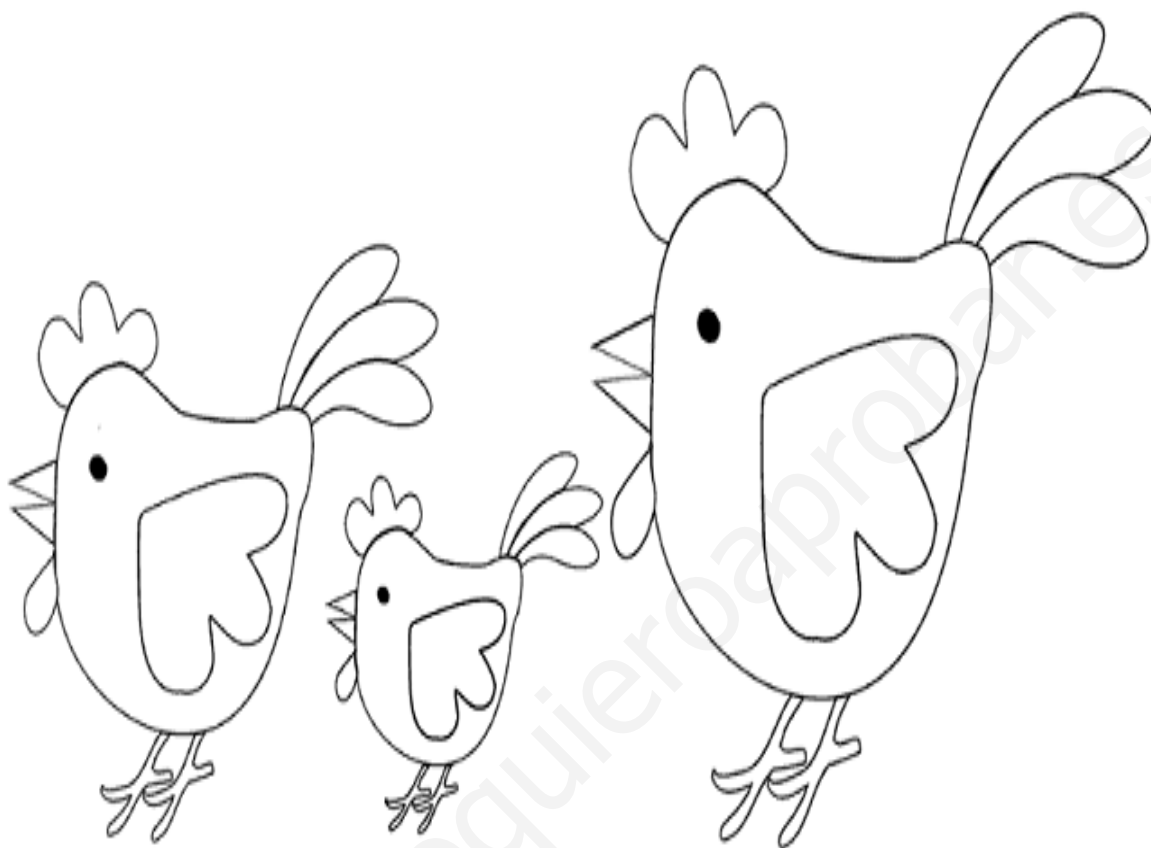

SEGUIMOS LA SERIE

www.yoquieroaprobar.es



SERIE:

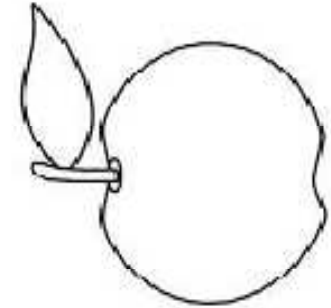
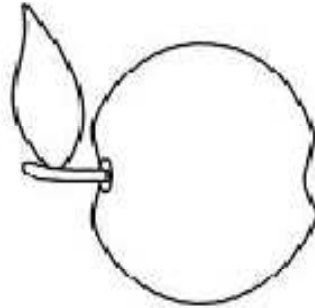
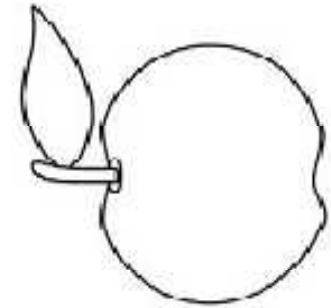
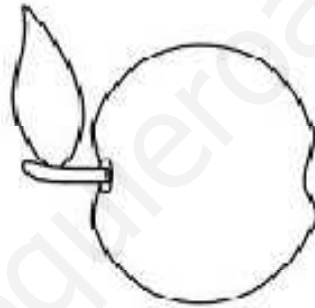
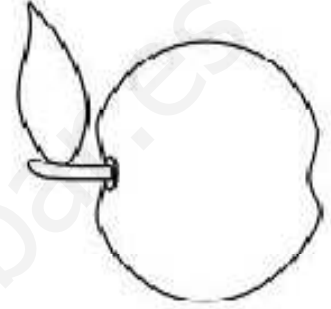
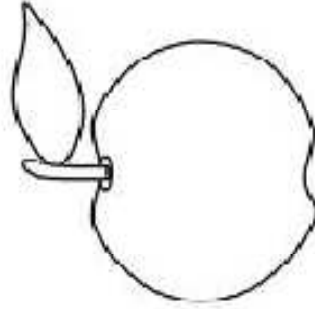
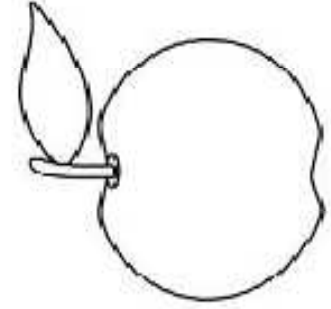
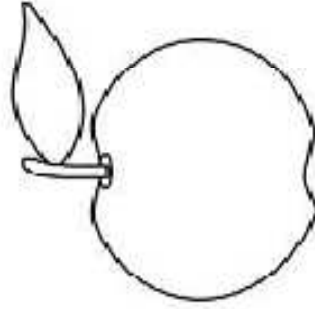

www.yoquieroaprobar.es

SERIE: 

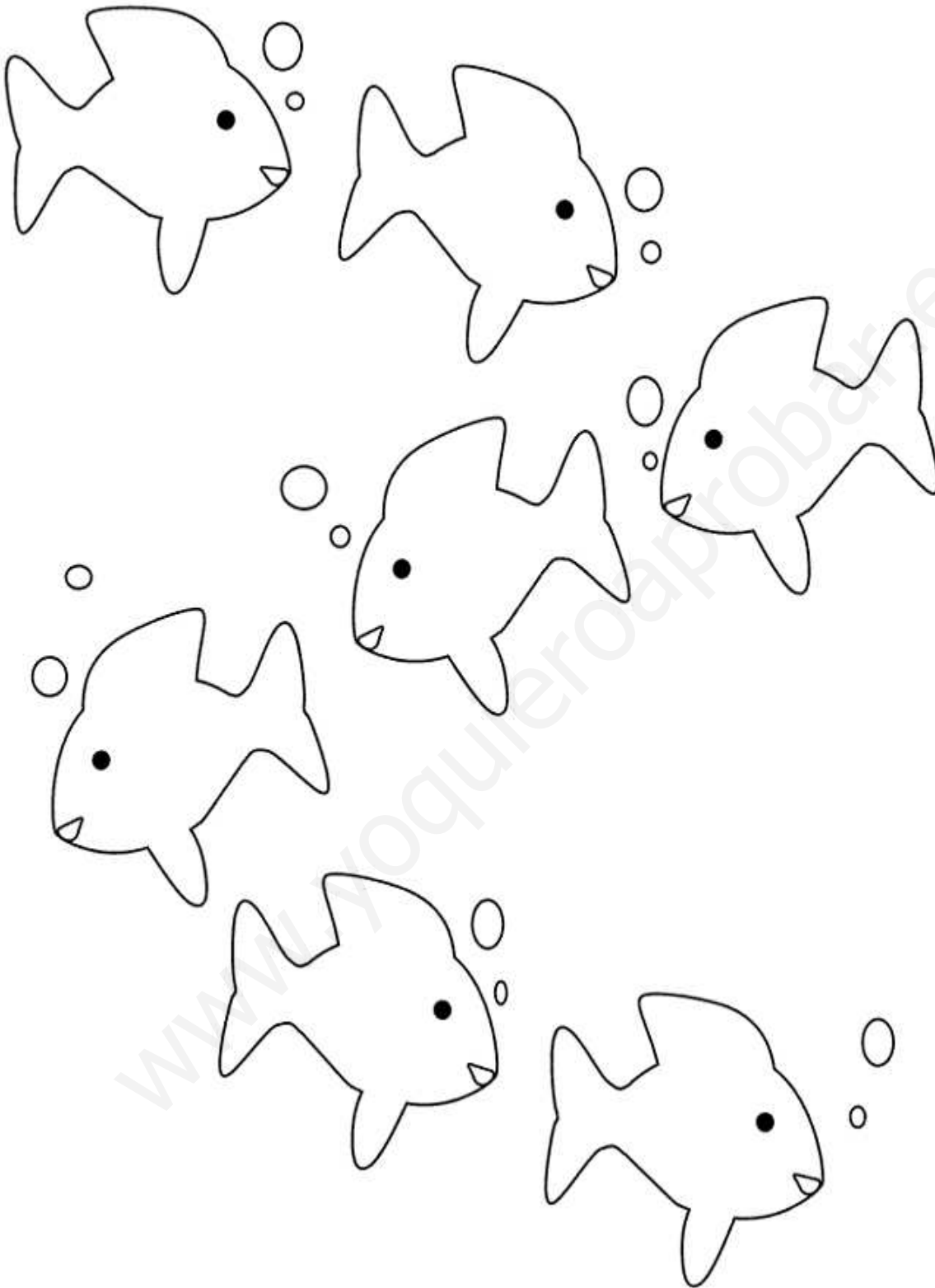

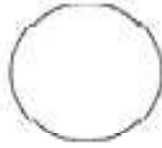

Rojo / Verde



Azul / Amarillo

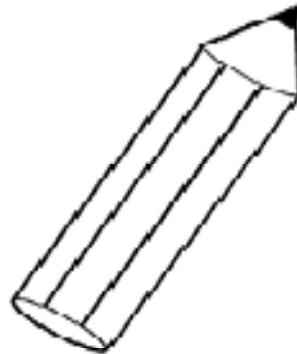

www.yoquieroaprobar.es