



www.yoquieroaprobar.es

SISTEMA DIÉDRICO EJERCICIOS DE VISTAS

NIVEL ELEMENTAL

Nombre: _____ Fecha: _____

Curso: _____ Grupo: _____

PIEZA N° 1

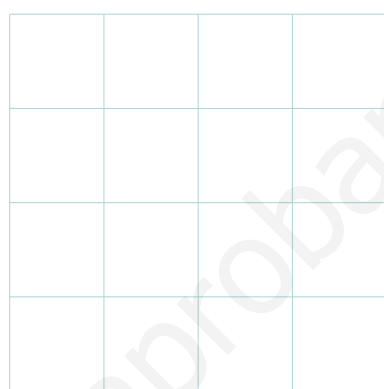
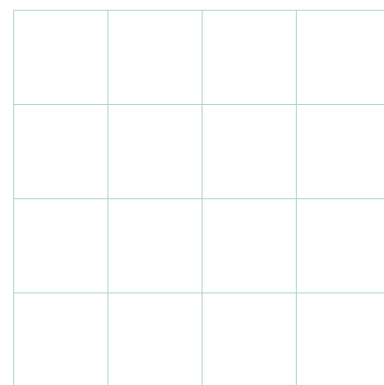
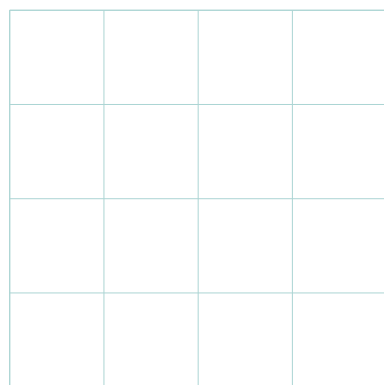
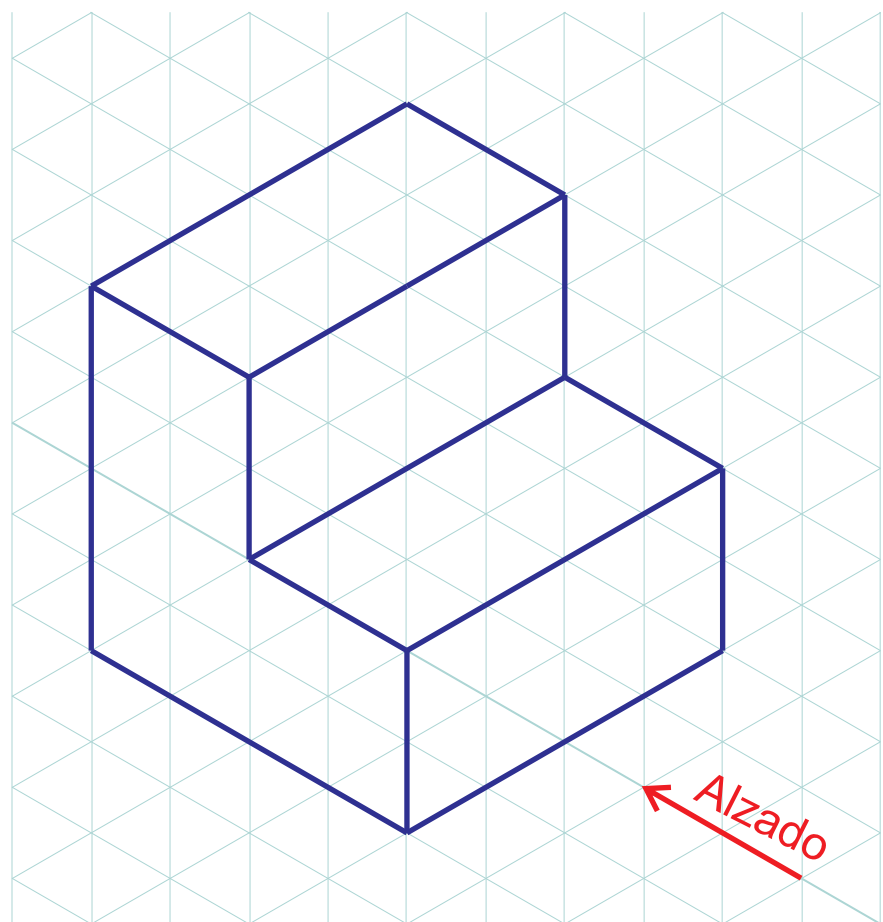

PIEZA N° 2

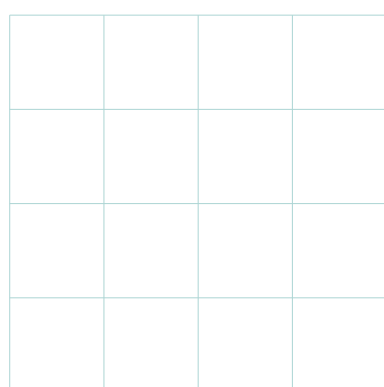
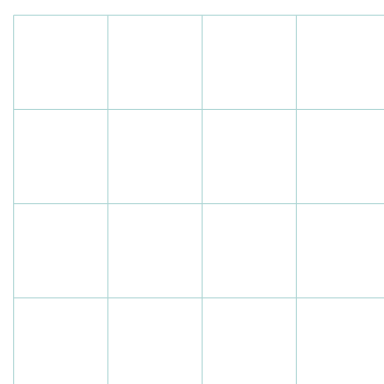
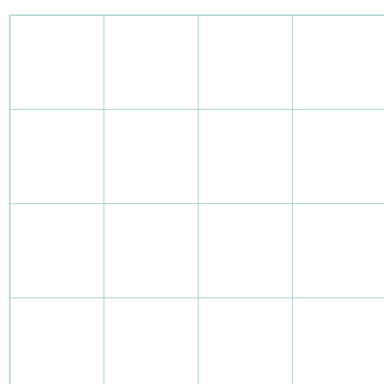
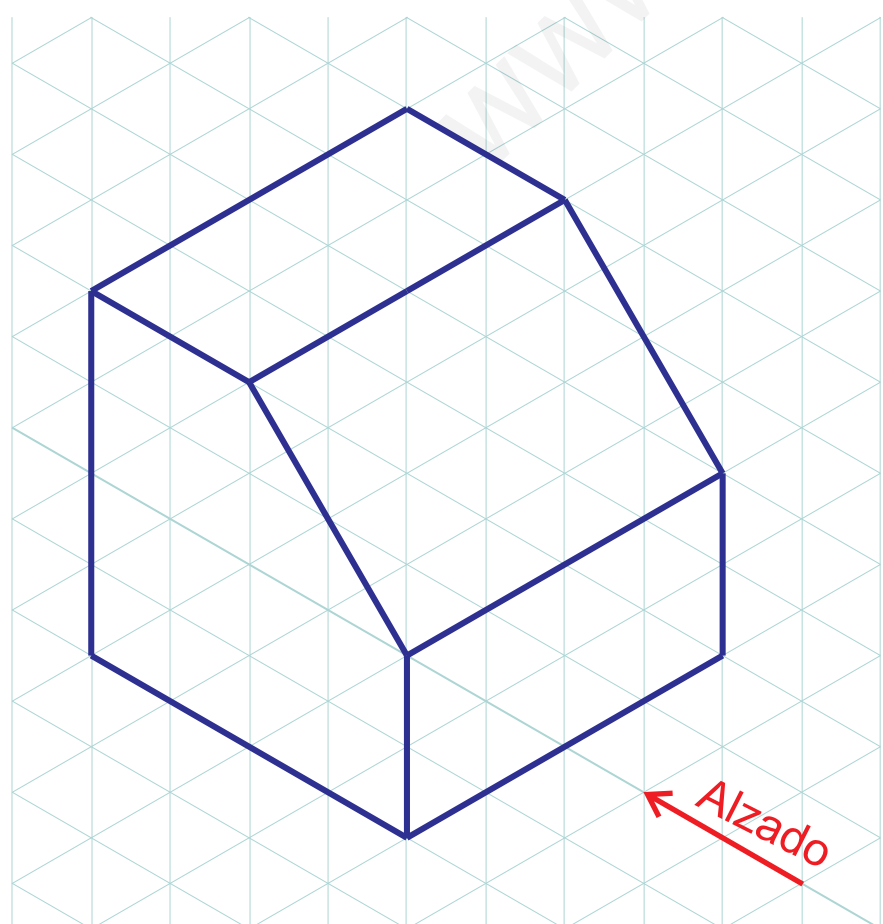

Nombre: _____ Fecha: _____

Curso: _____ Grupo: _____

PIEZA N° 3

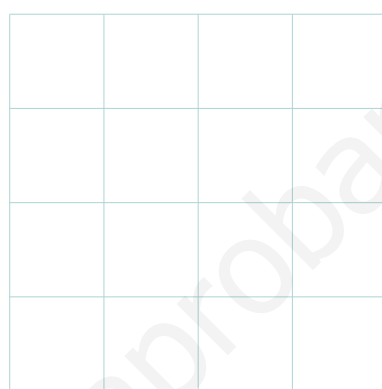
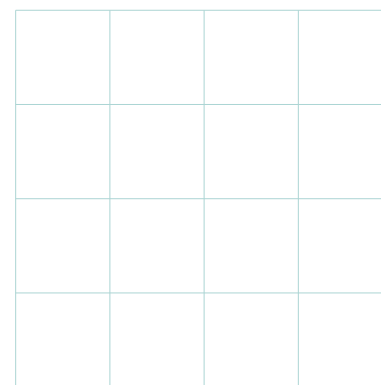
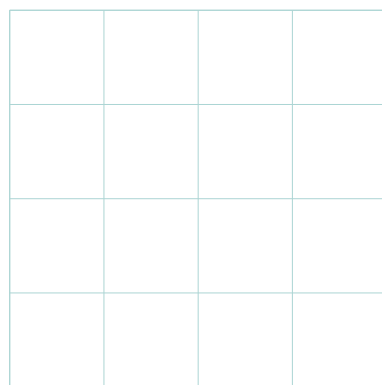
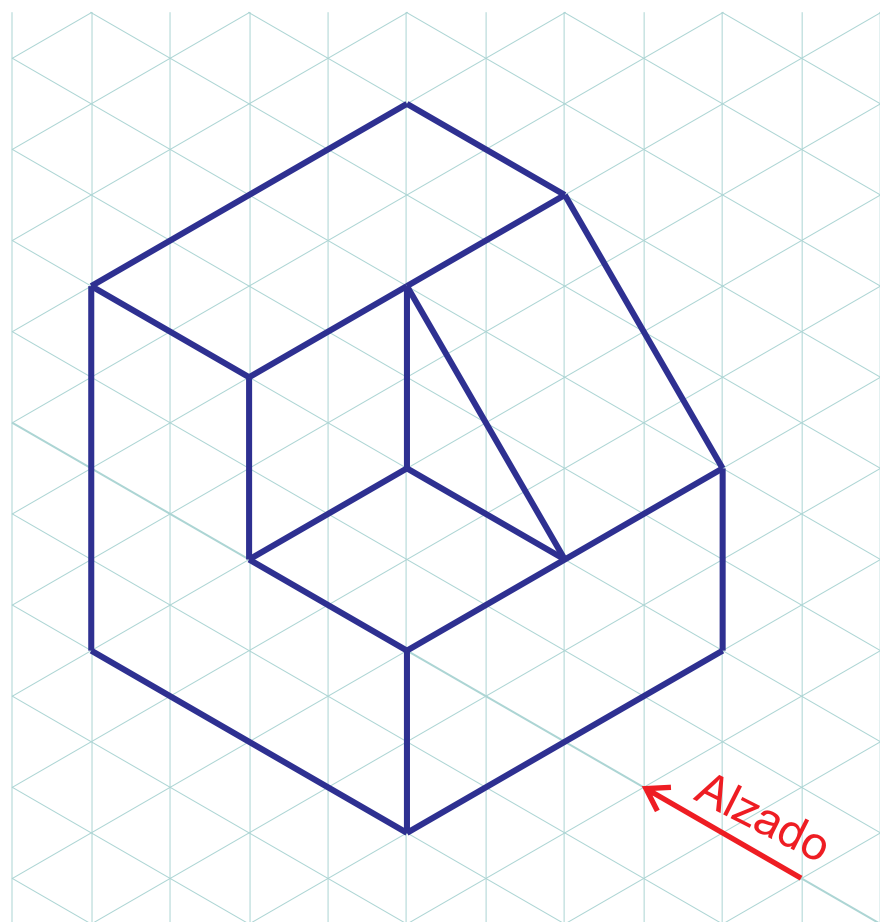

PIEZA N° 4

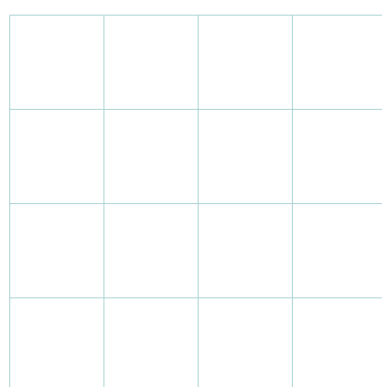
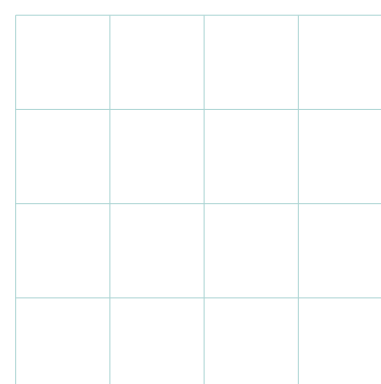
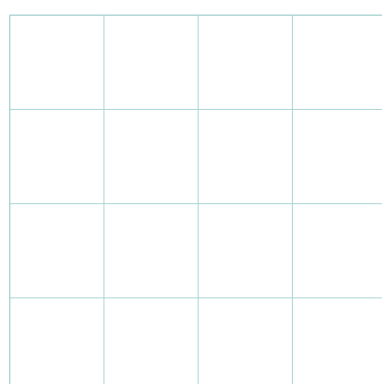
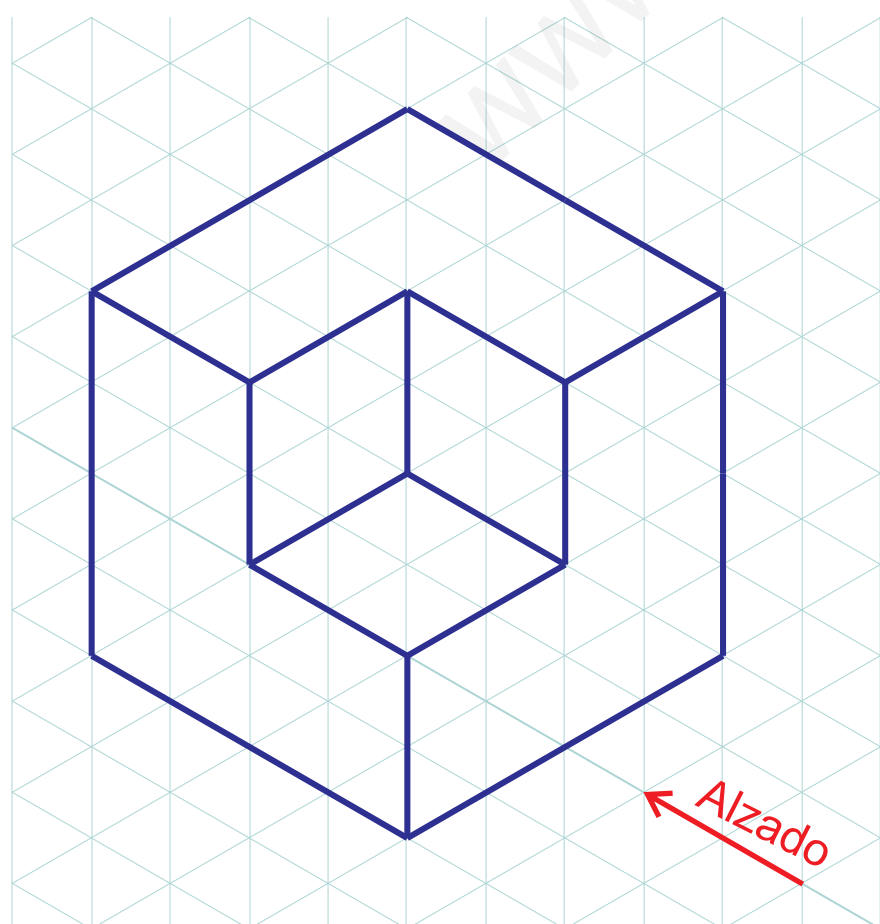

Nombre: _____ Fecha: _____

Curso: _____ Grupo: _____

PIEZA N° 5

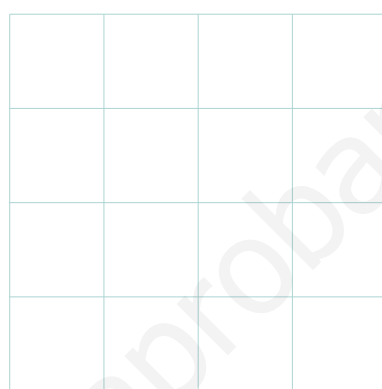
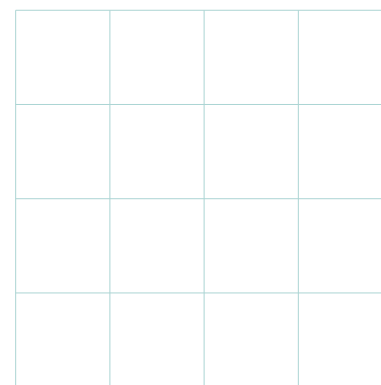
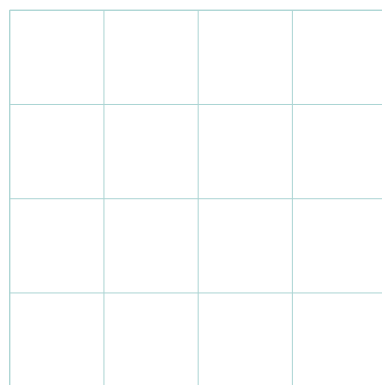
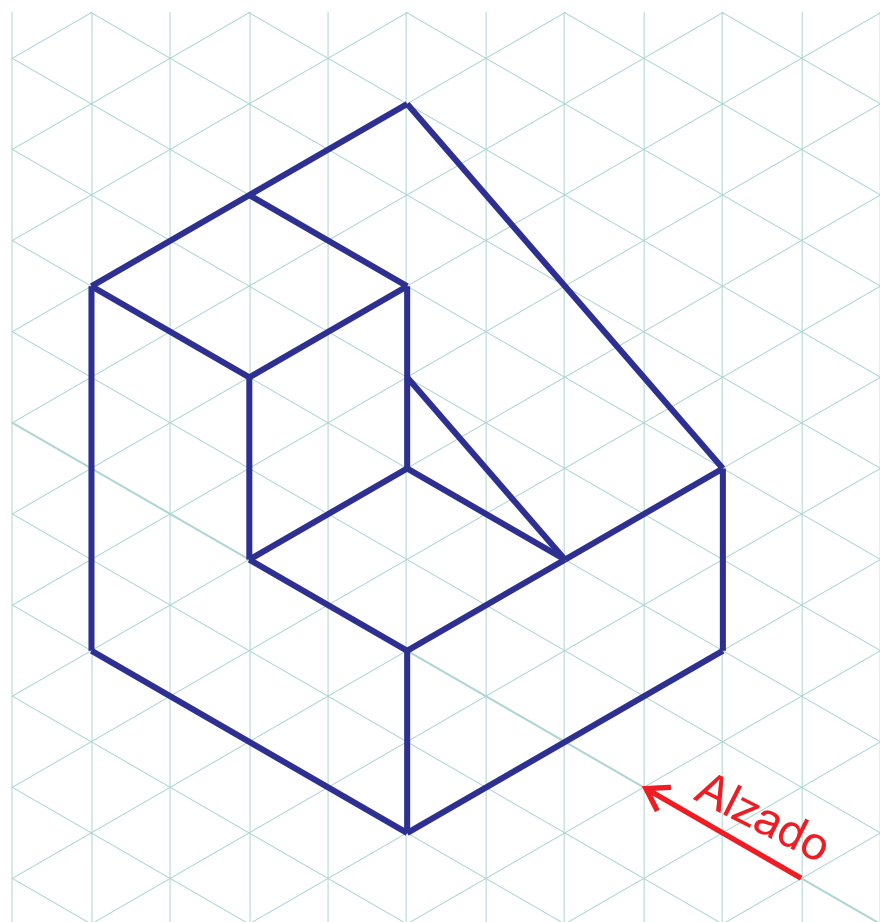

PIEZA N° 6

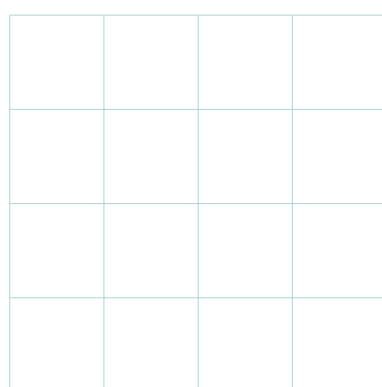
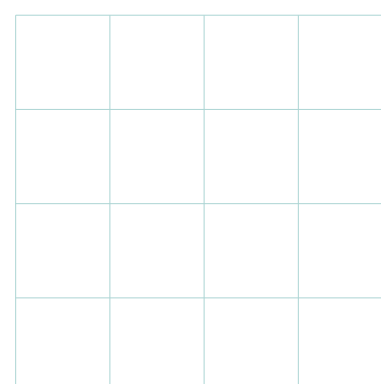
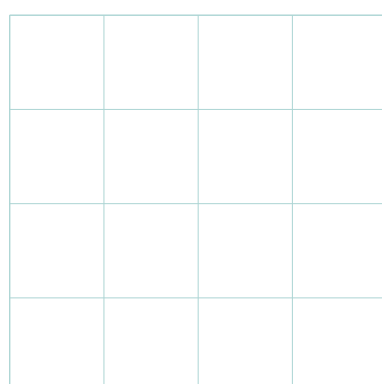
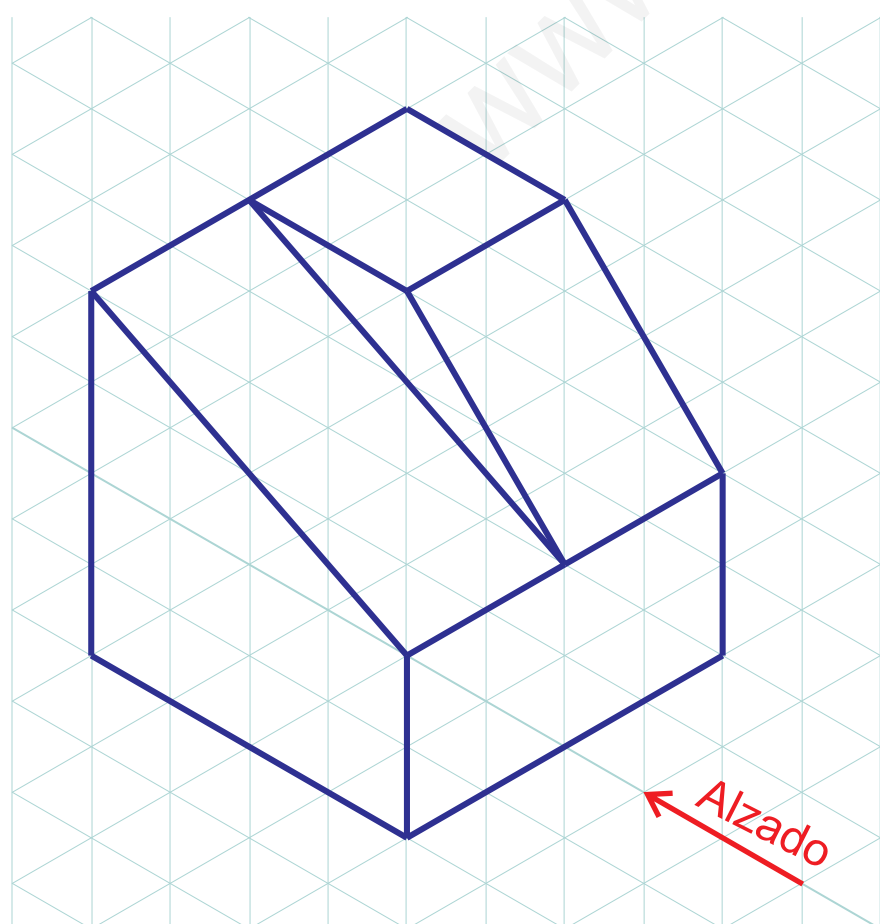

Nombre: _____ Fecha: _____

Curso: _____ Grupo: _____

PIEZA N° 7

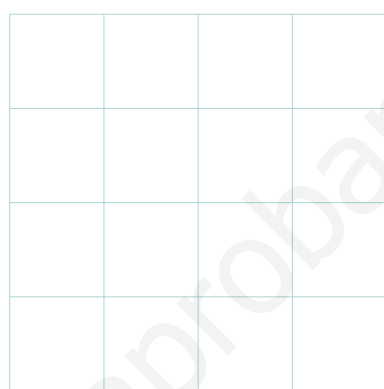
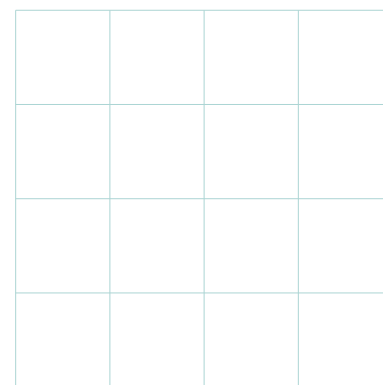
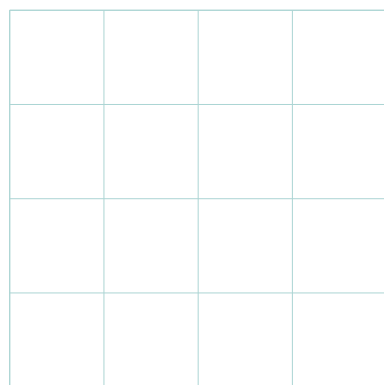
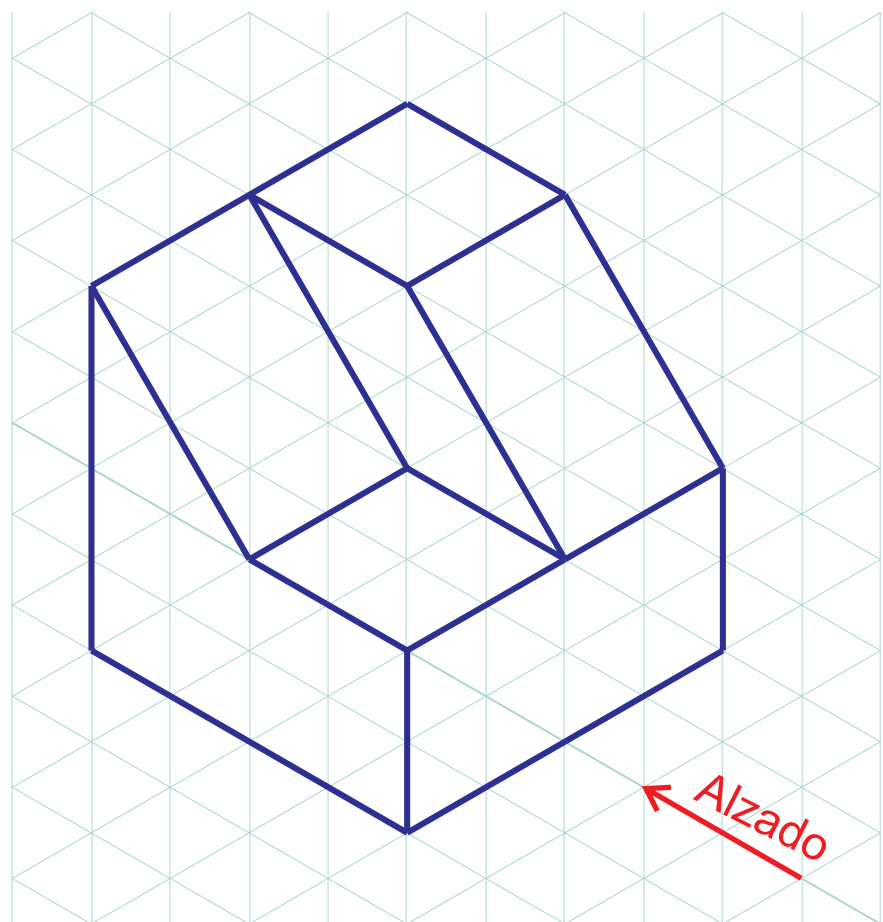

PIEZA N° 8

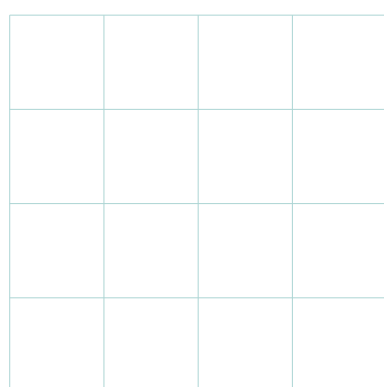
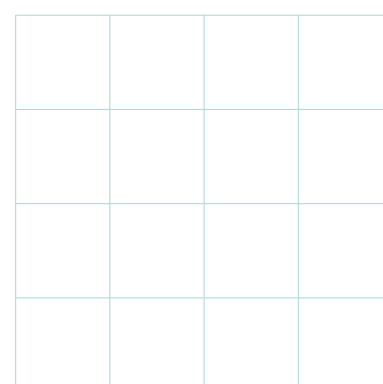
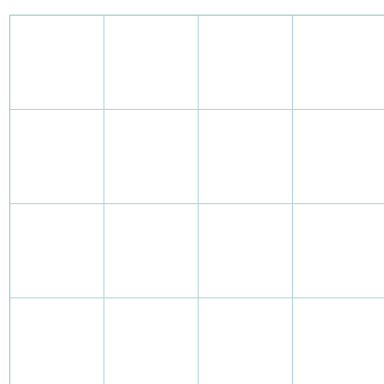
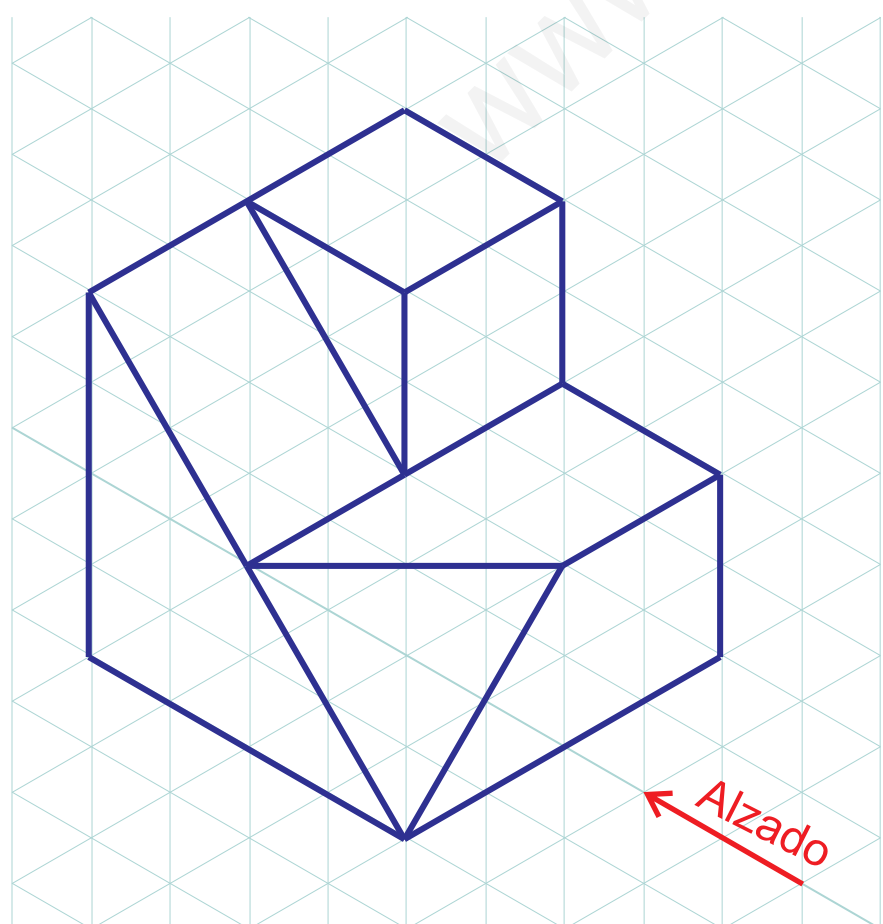

Nombre: _____ Fecha: _____

Curso: _____ Grupo: _____

PIEZA N° 9

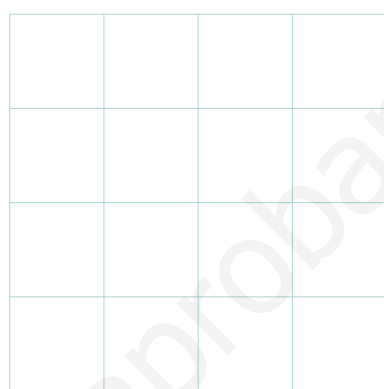
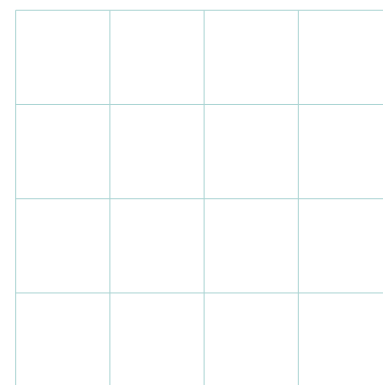
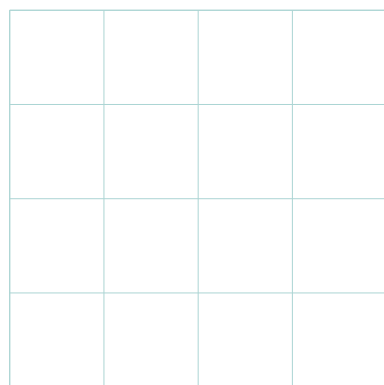
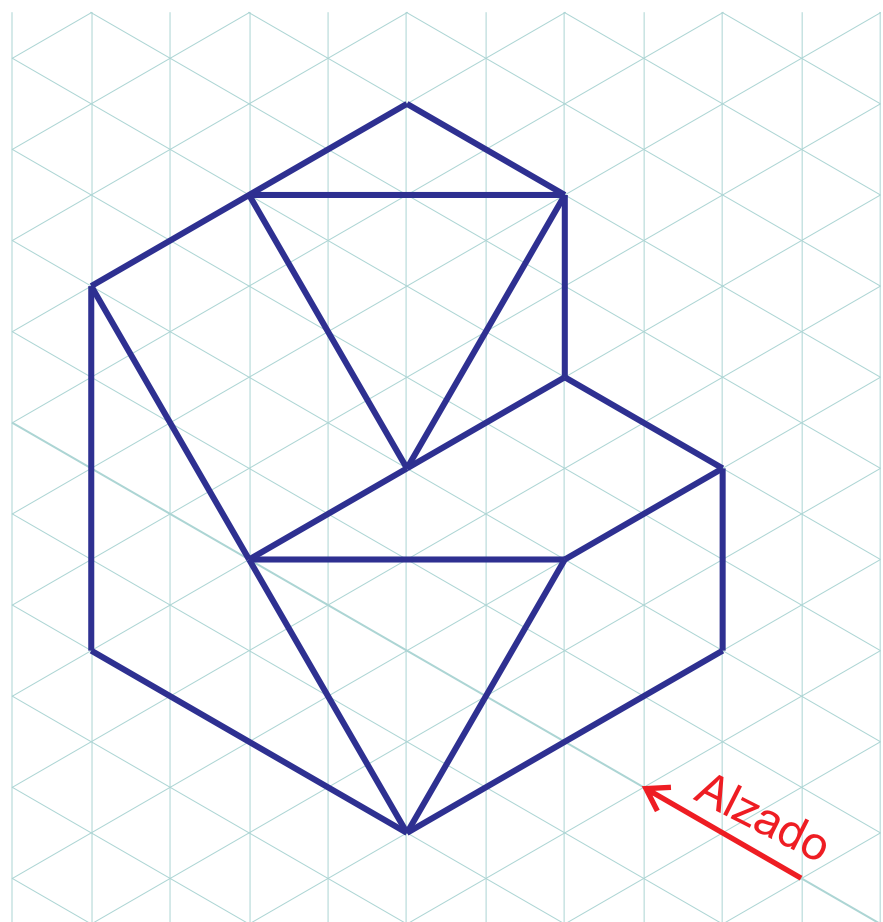

PIEZA N° 10

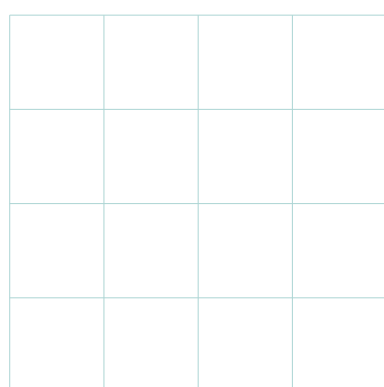
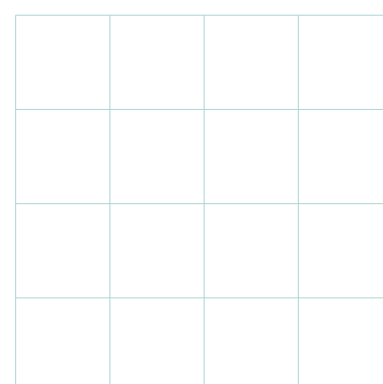
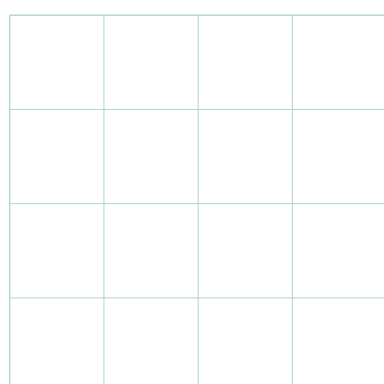
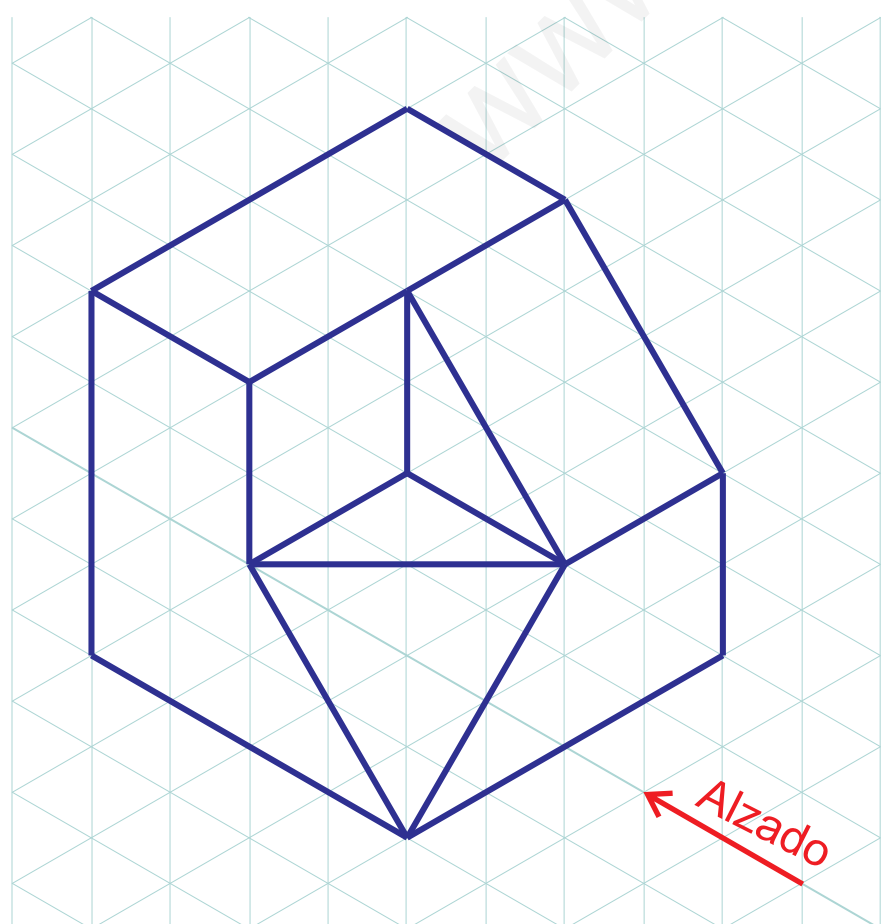

Nombre: _____ Fecha: _____

Curso: _____ Grupo: _____

PIEZA N° 11

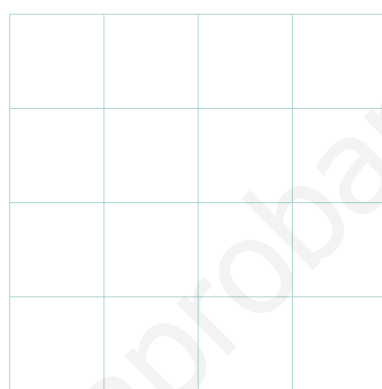
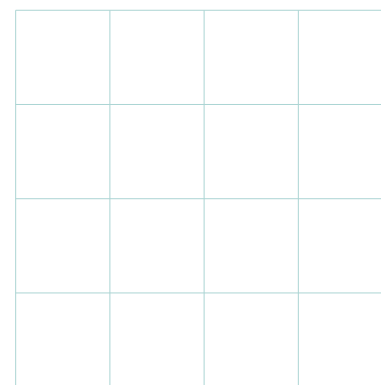
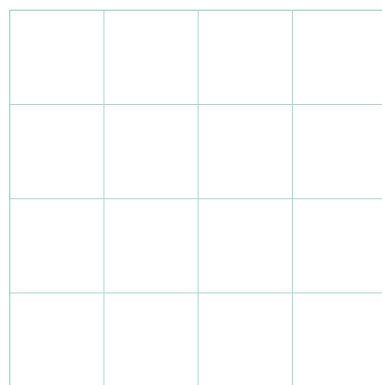
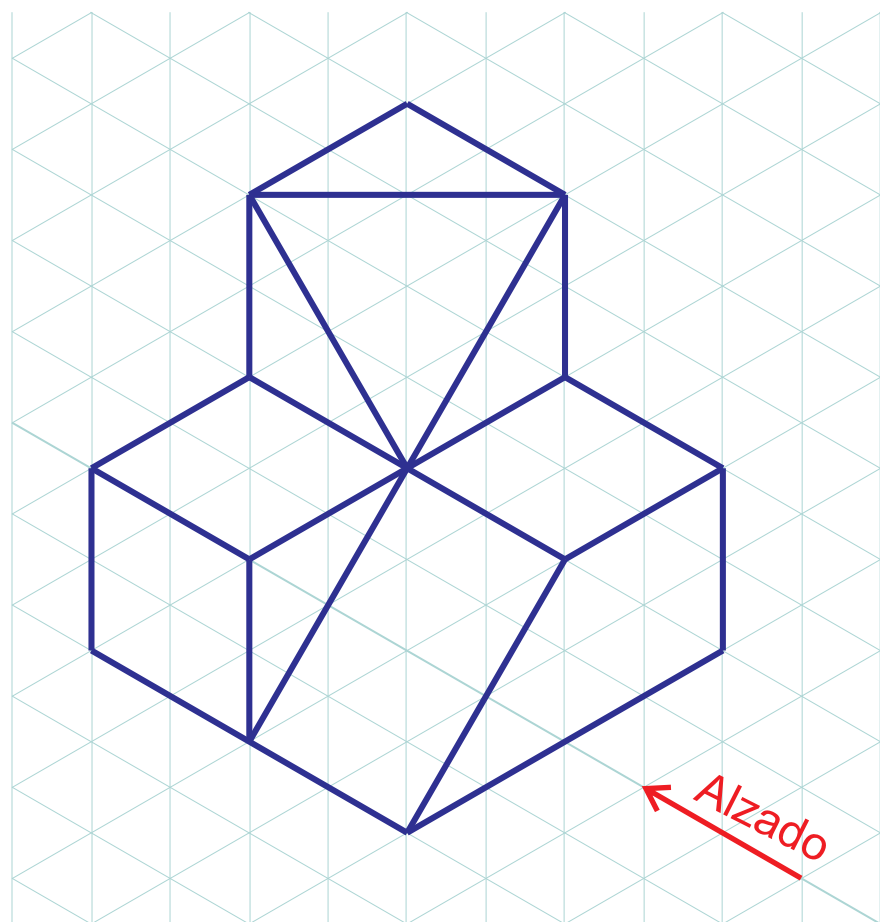

PIEZA N° 12

