



MANUAL DE ACTIVIDADES PARA EL ALUMNO

ATENCIÓN Y MEMORIA

4



Manuel Delgado



LÍNEAS CRUZADAS

Sigue las líneas y dibuja cada uno de los objetos en el lugar que corresponda. Píntalos.

OBJETOS ESCONDIDOS

El niño perdió la mochila, la lonchera y la pelota. Ayúdale a buscarlas y enciérralas.



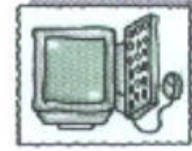

LÍNEAS CRUZADAS

Sigue las líneas y dibuja cada uno de los objetos en el lugar que corresponda. Píntalos.

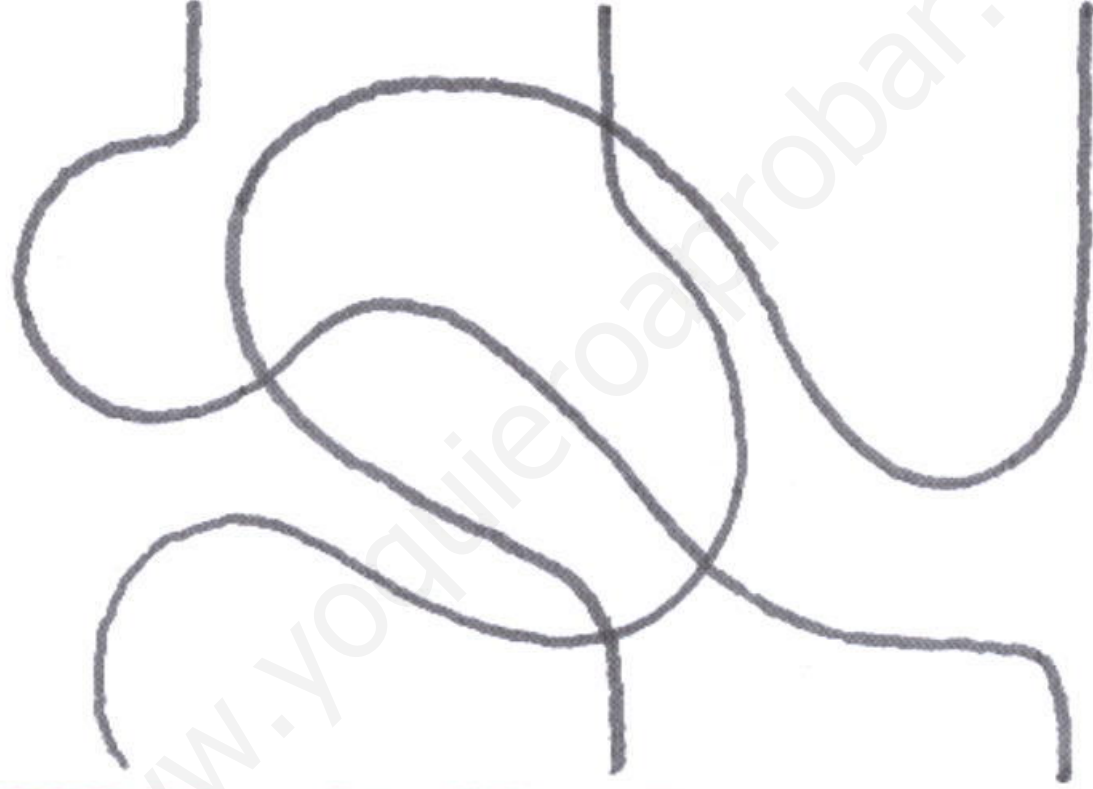
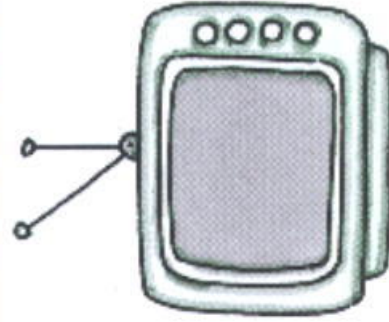
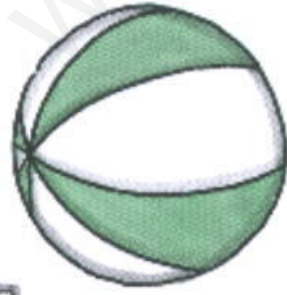

www.yoquieroaprobar.es



ASOCIACIÓN DE CLAVES

Completa los cuadrados y los círculos según las claves.

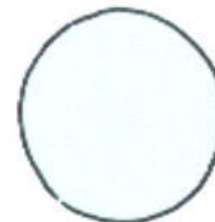
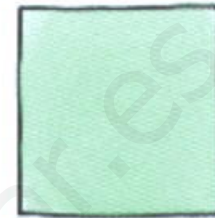
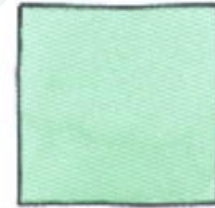
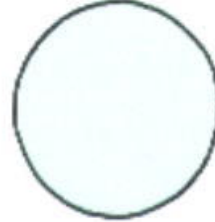
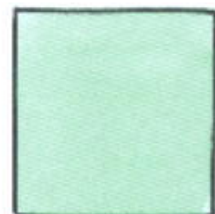
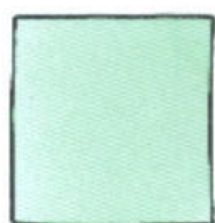
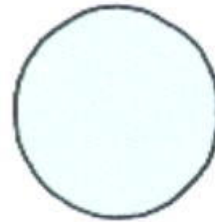
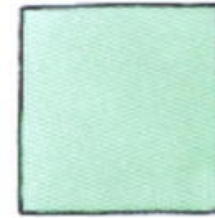
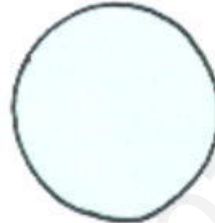
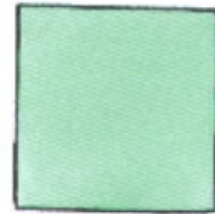
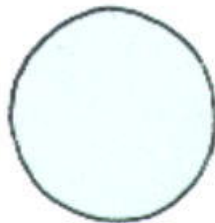
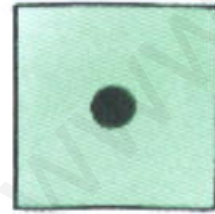
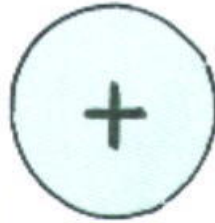



RECONOCIMIENTO DE PROPIEDADES

Pinta de color amarillo las hojas **grandes** y de color café las **pequeñas**.

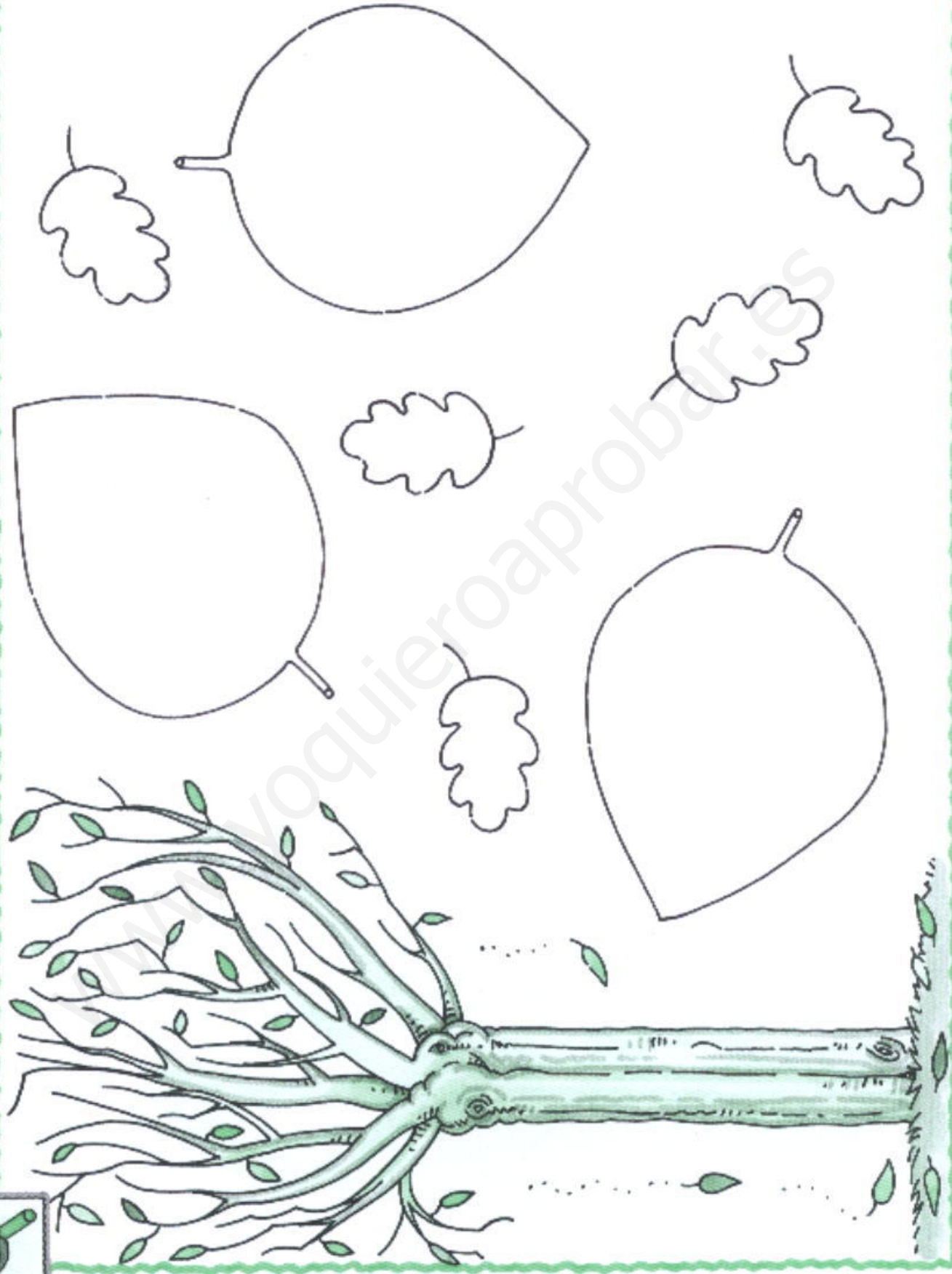

RECONOCIMIENTO DE PROPIEDADES

Pinta el hongo mediano.

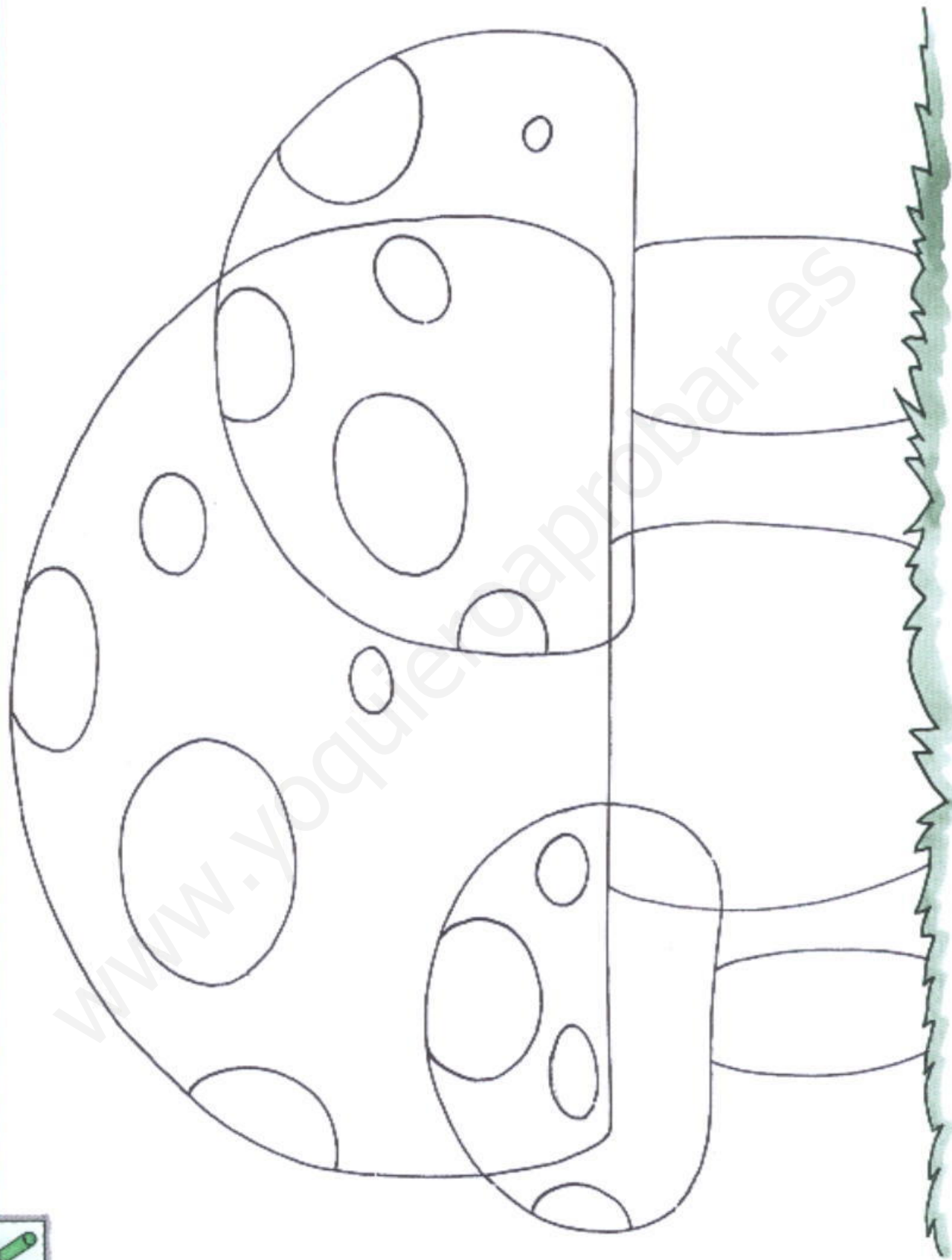



LÍNEAS CRUZADAS

Sigue las líneas y dibuja cada una de las figuras en el lugar que corresponda. Píntalas.

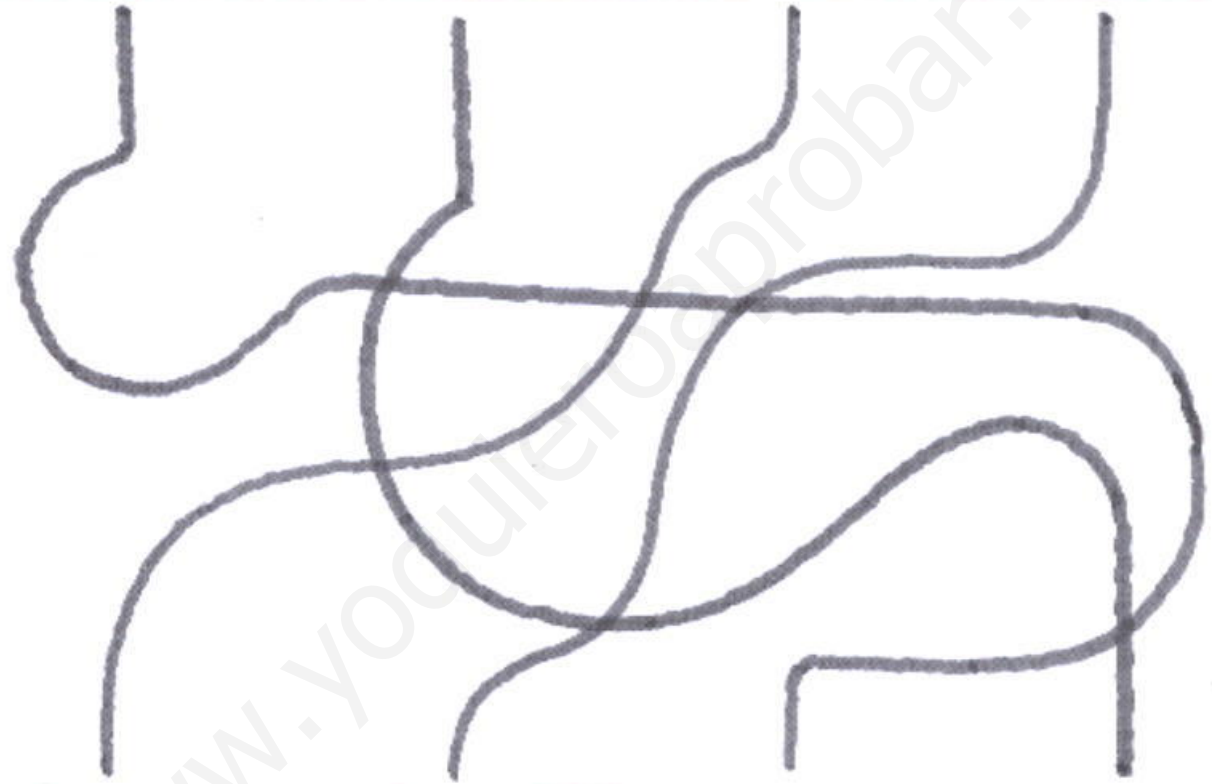
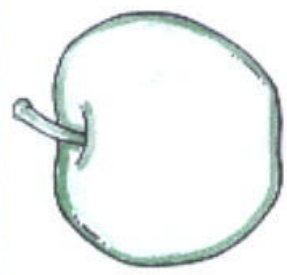
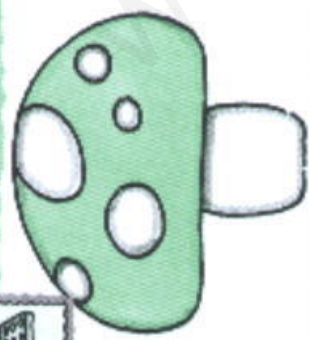

www.yoculieroaprobar.es

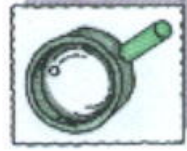

SEMEJANZAS Y DIFERENCIAS

Busca y tacha los juguetes diferentes. Une con flechas los que son iguales.

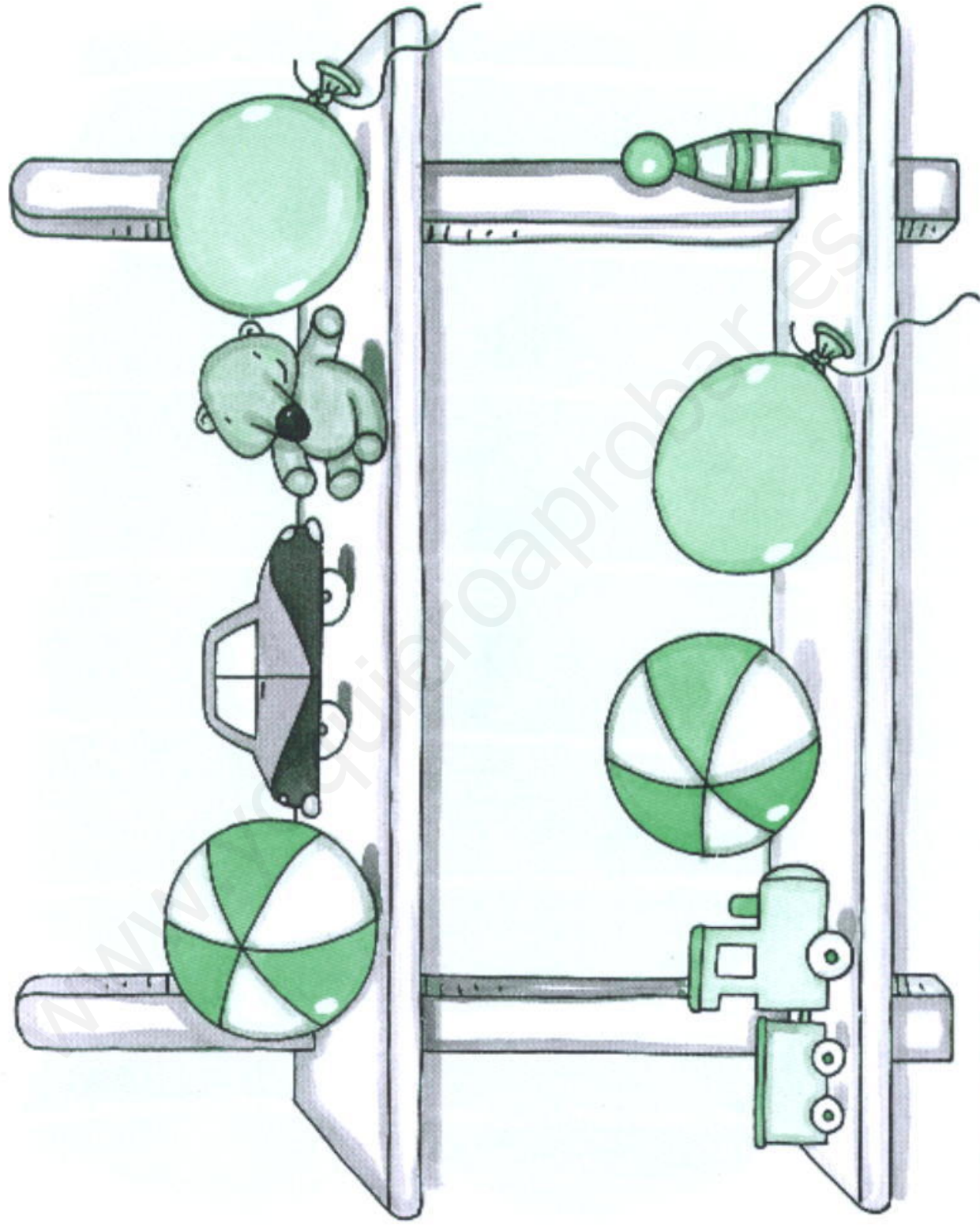



DISTINCIÓN FIGURA-FONDO
Descubre y pinta los triángulos.

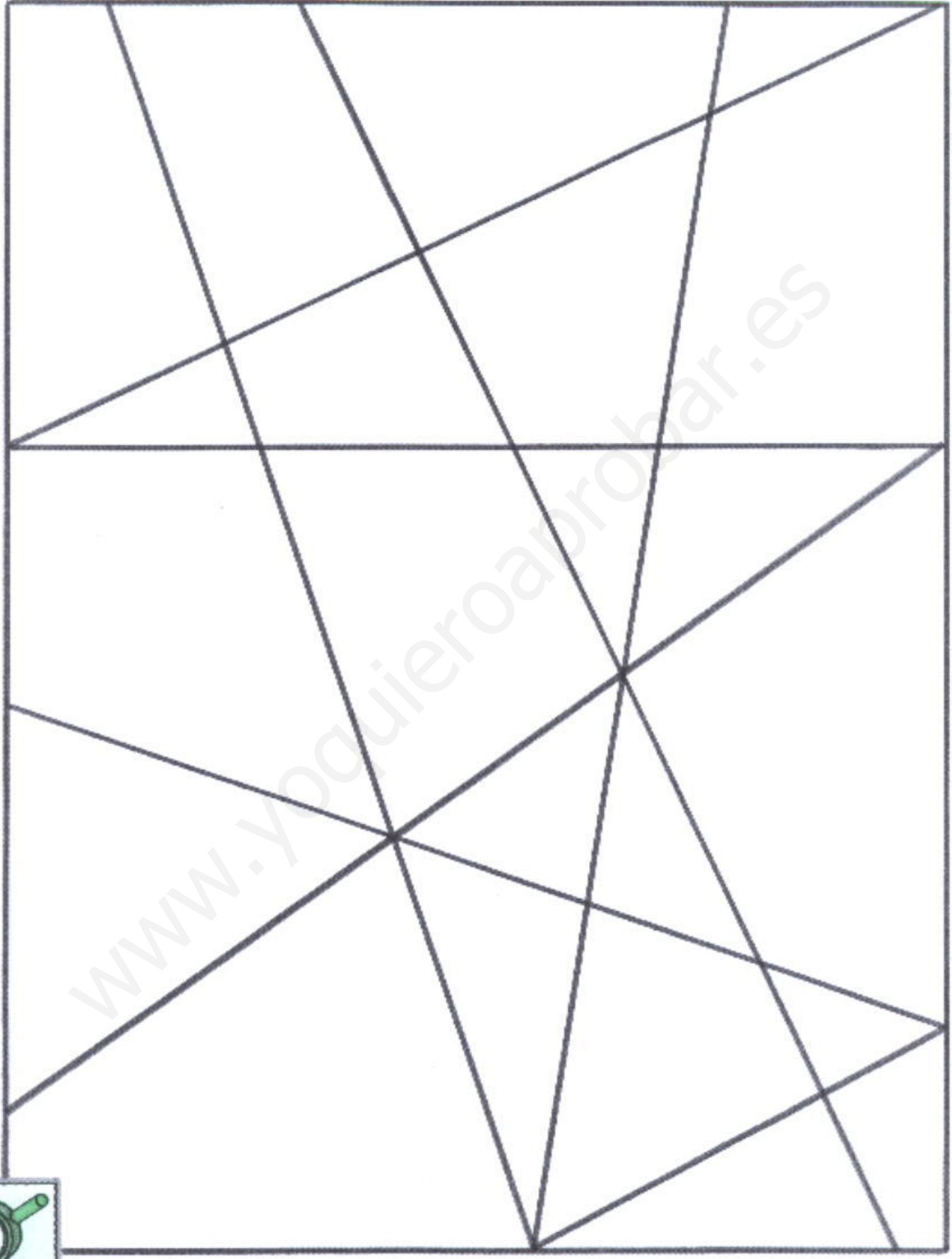

www.yoquieroaprobar.es



ASOCIACIÓN DE CLAVES

Completa las figuras según la clave.

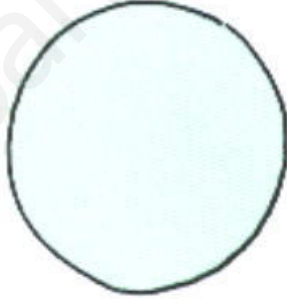
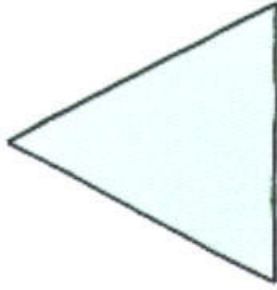
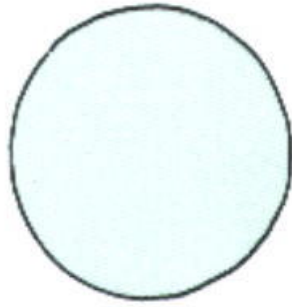
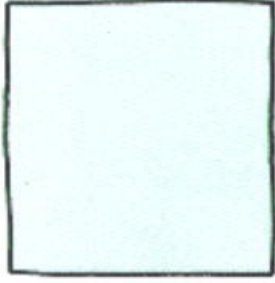
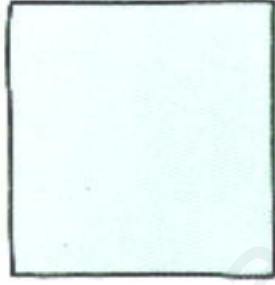
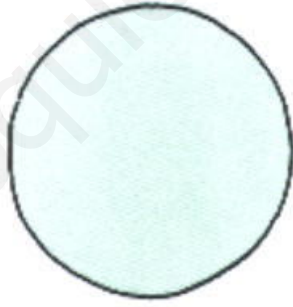
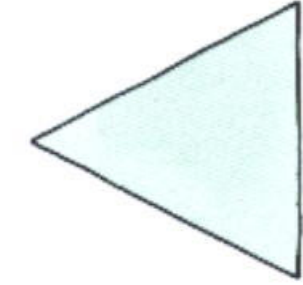
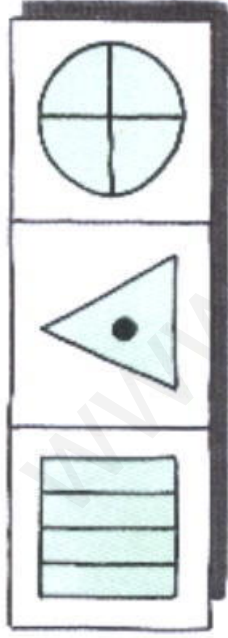



DISTINCIÓN FIGURA-FONDO

Encuentra y pinta la camiseta con mangas.

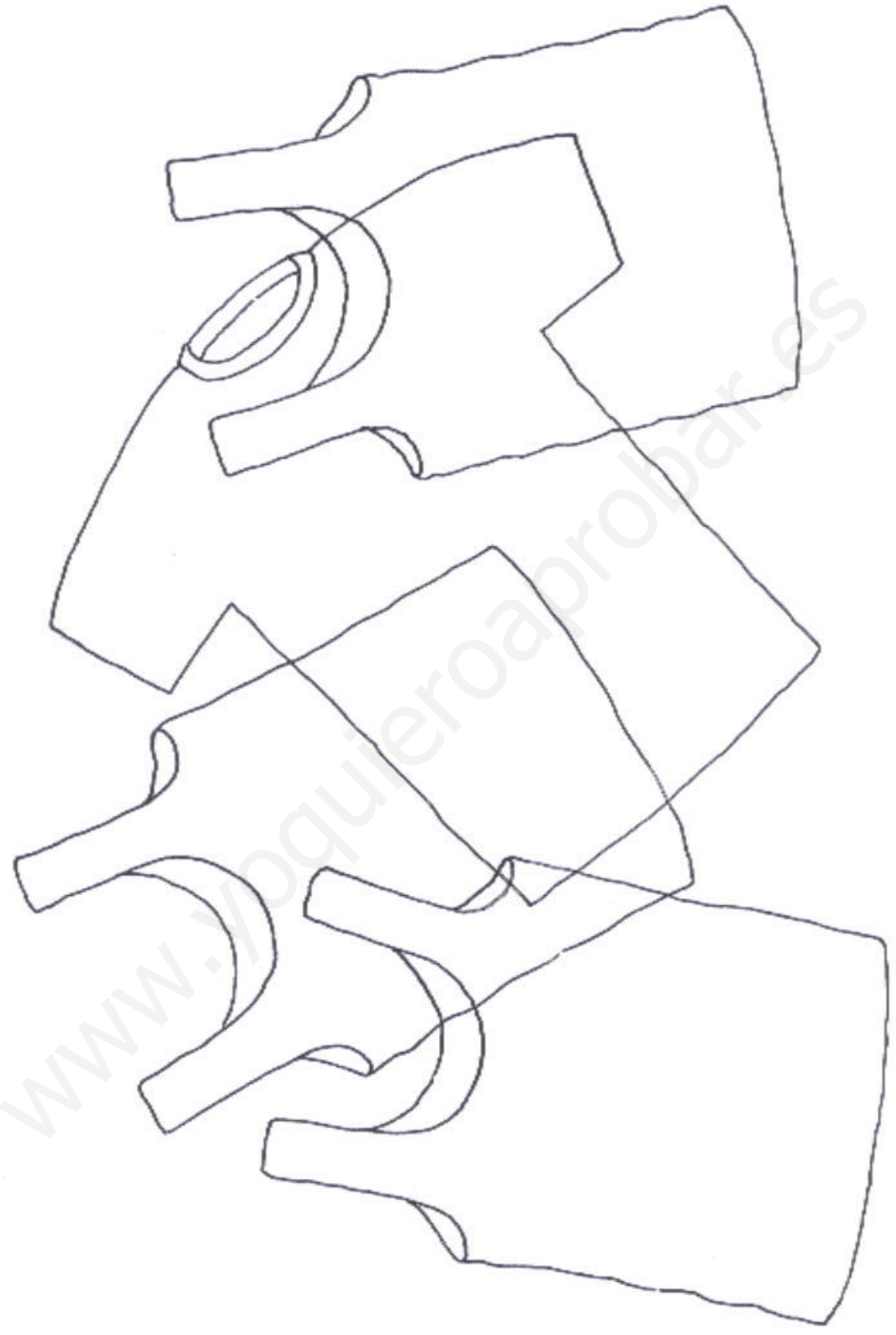

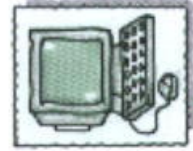

MEMORIZACIÓN DE DIBUJOS

Observa el modelo y tápalo. Completa las demás caras.

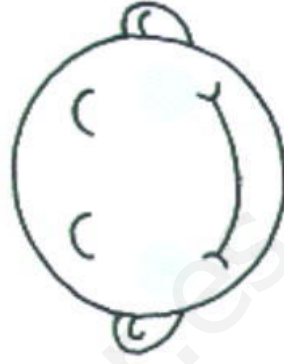
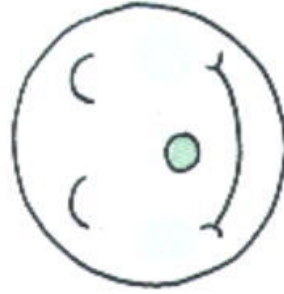
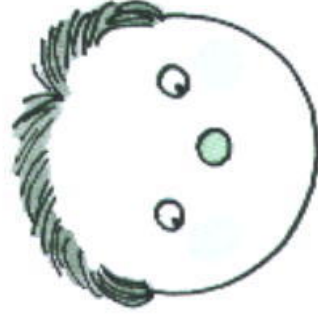
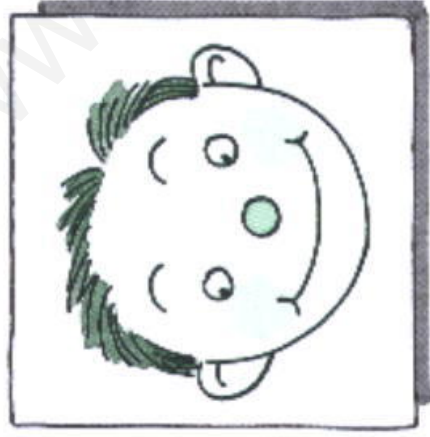

DISTINCIÓN FIGURA-FONDO

Pinta, según la clave, de color: (-) rosado, (+) azul, y encuentra el dibujo escondido.

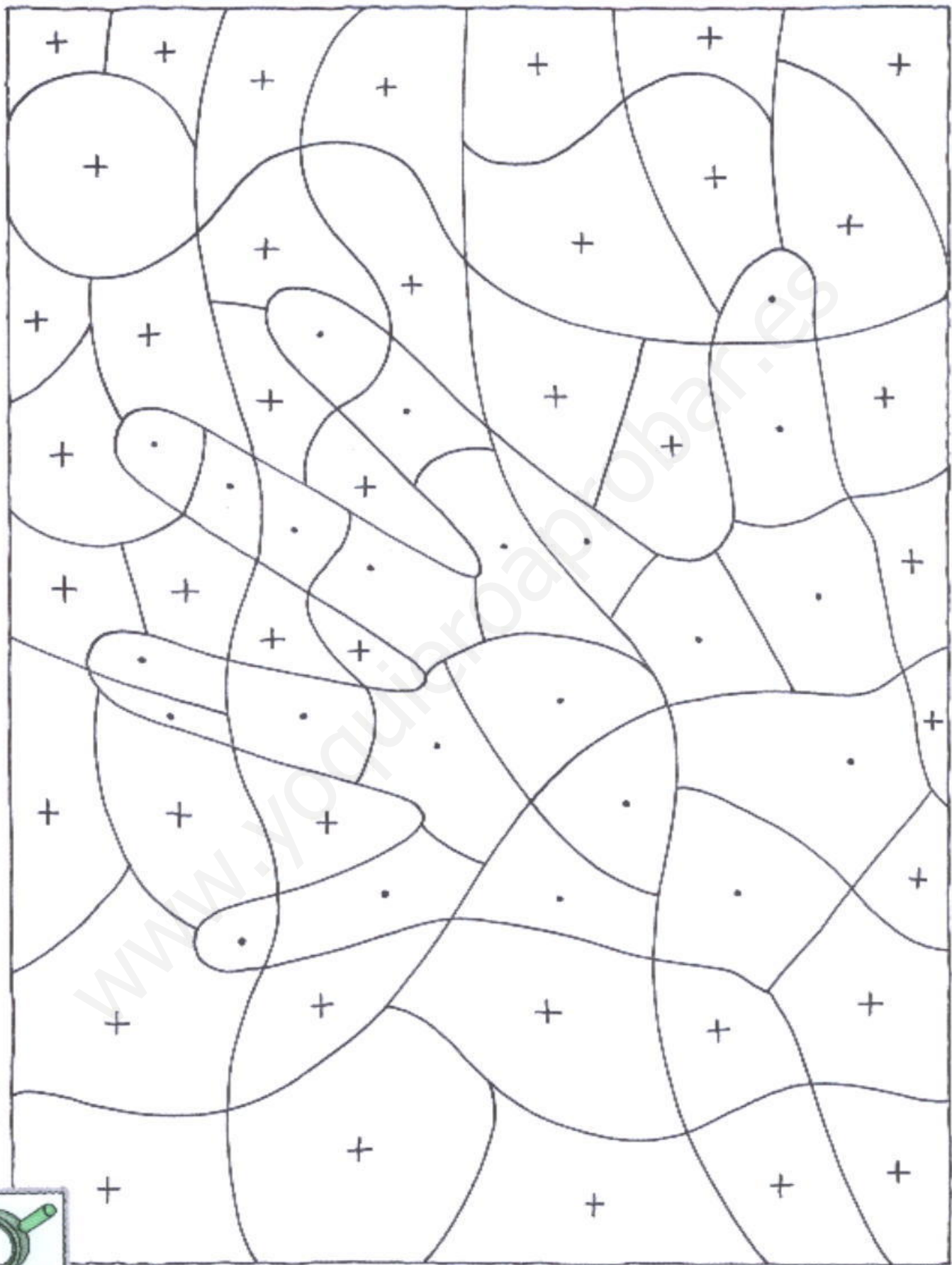
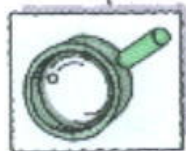



LÍNEAS CRUZADAS

Puntea las figuras. Sigue las líneas y pega cada una de las figuras en el lugar que corresponda. Píntalas.

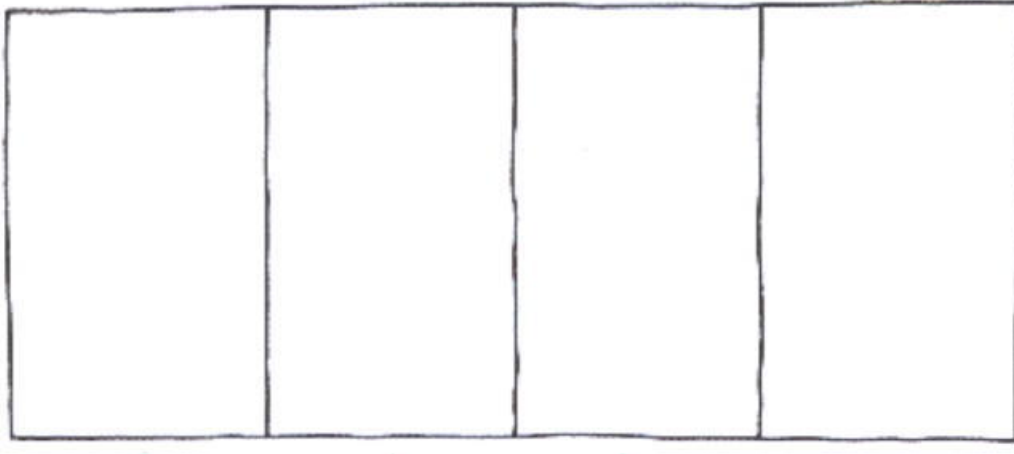
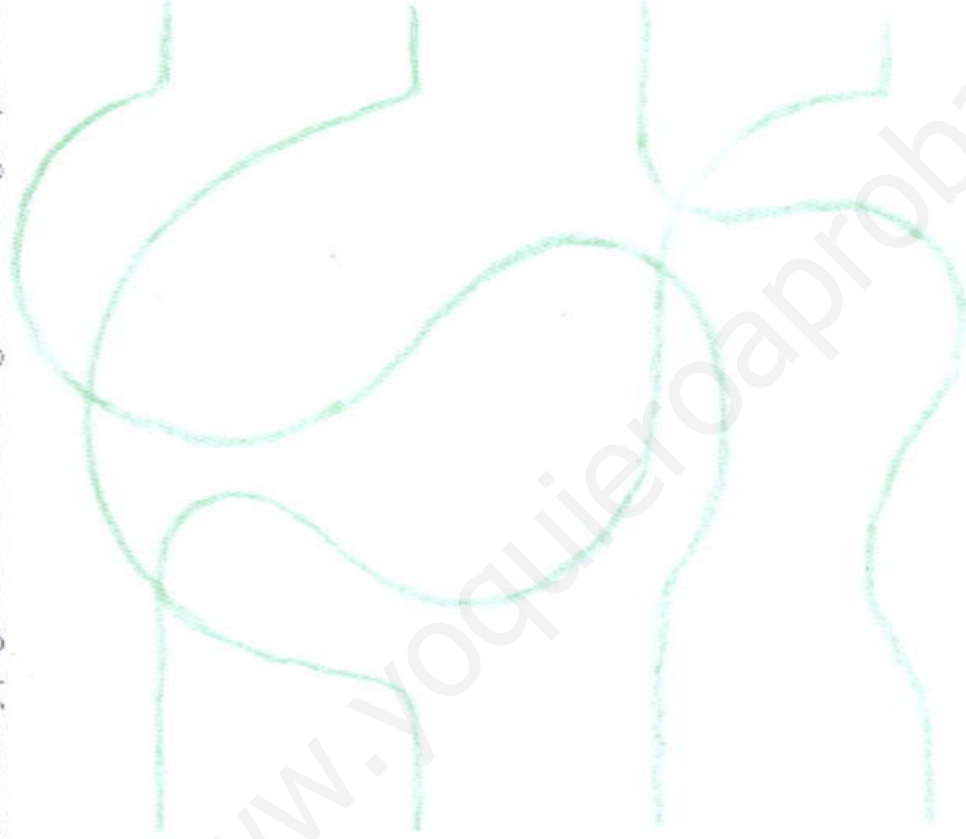
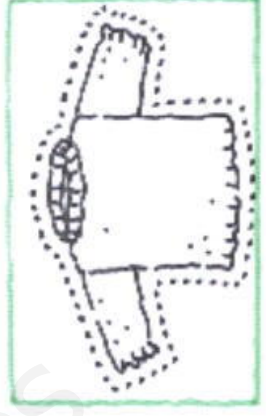
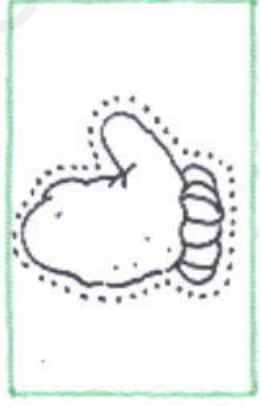
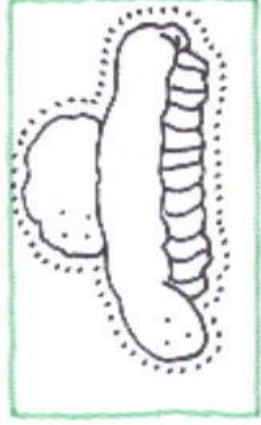
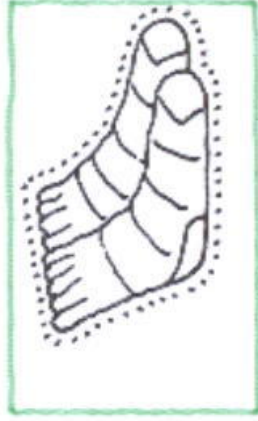
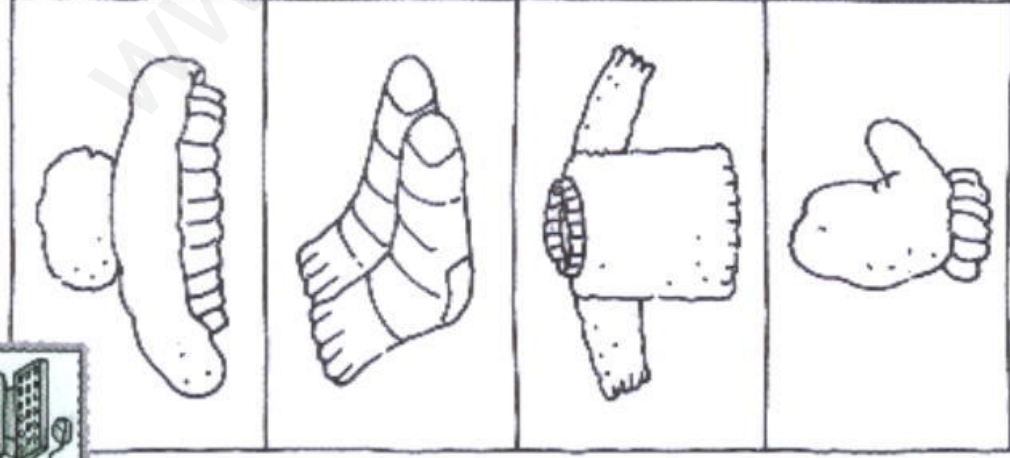

www.yoquieroaprobar.es



MEMORIZACIÓN DE DIBUJOS

Observa los modelos y tápalos. Tacha las figuras iguales al modelo.

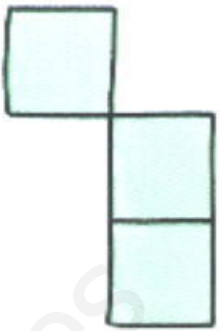
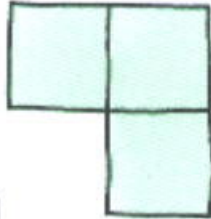
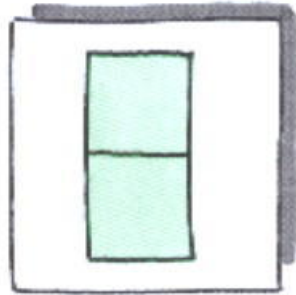
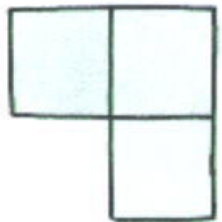
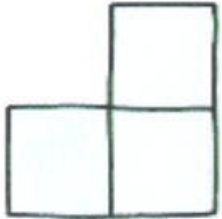
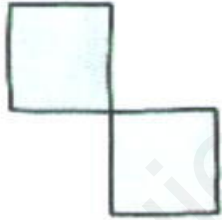
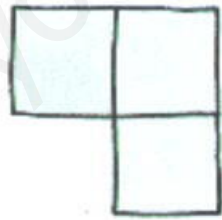
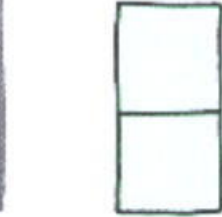
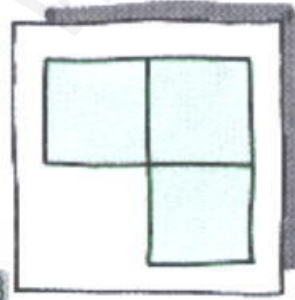



DIBUJOS INCOMPLETOS

Completa lo que le falta al payaso. Pinta el modelo.

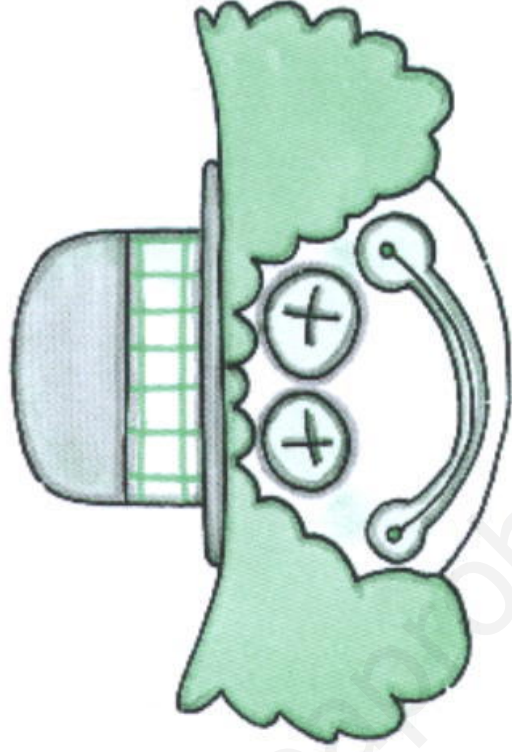
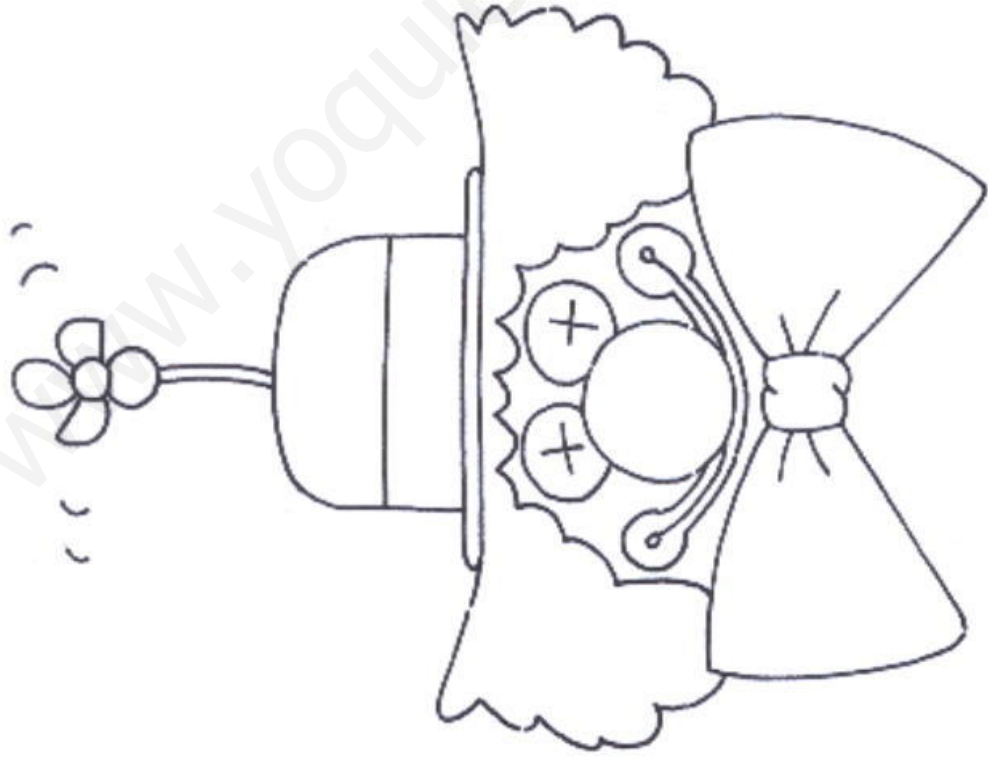



RECONOCIMIENTO DE PROPIEDADES

Traza el camino que corresponde a cada niño para llegar a su antifaz.

OBJETOS ESCONDIDOS

Busca y encierra los **antifaces** de color azul y los **pitos serpientes** de color verde.

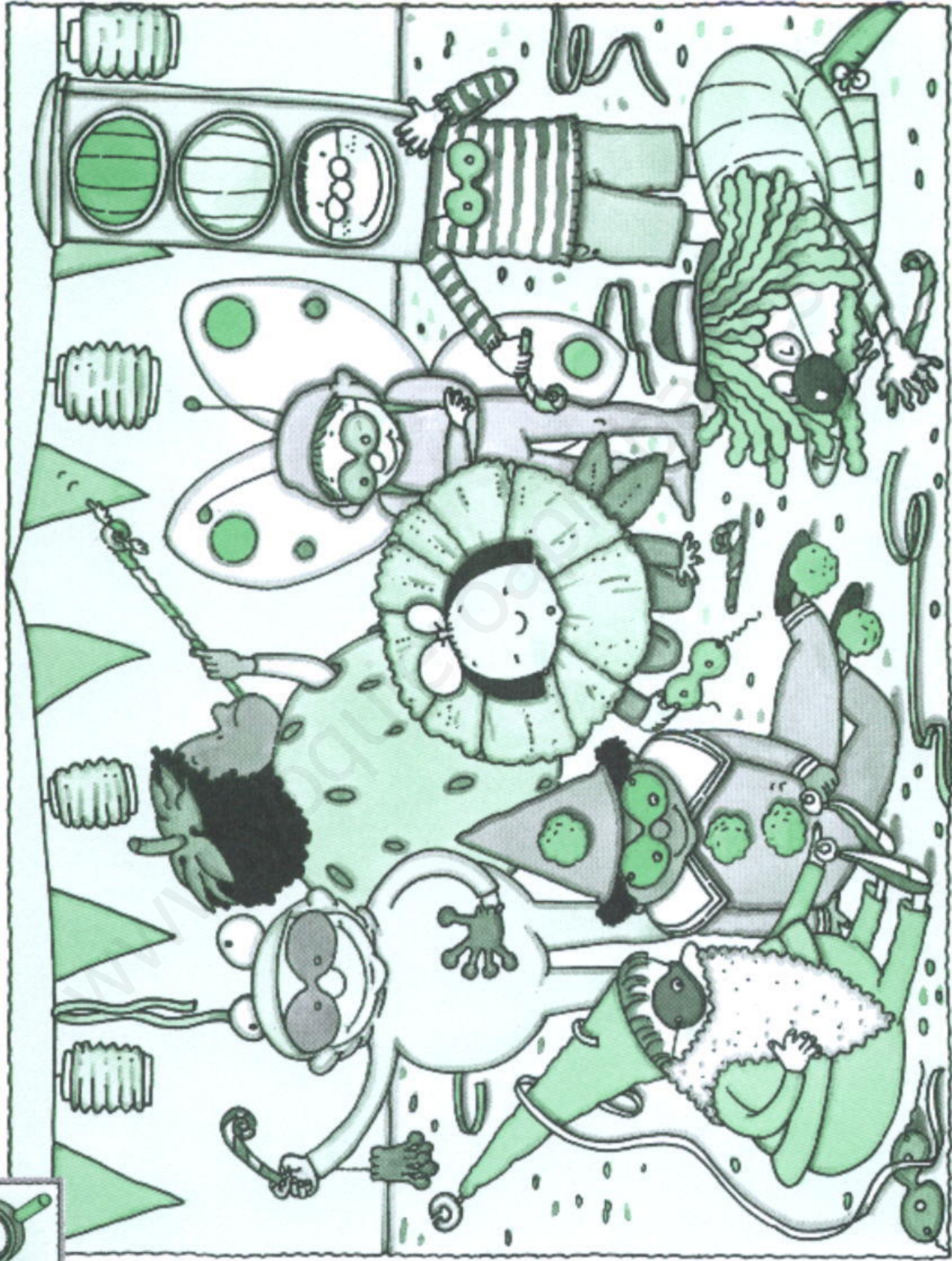



ASOCIACIÓN DE CLAVES

Pinta el dibujo, según la clave, de color: (+) verde, (o) rojo y (*) rosado.

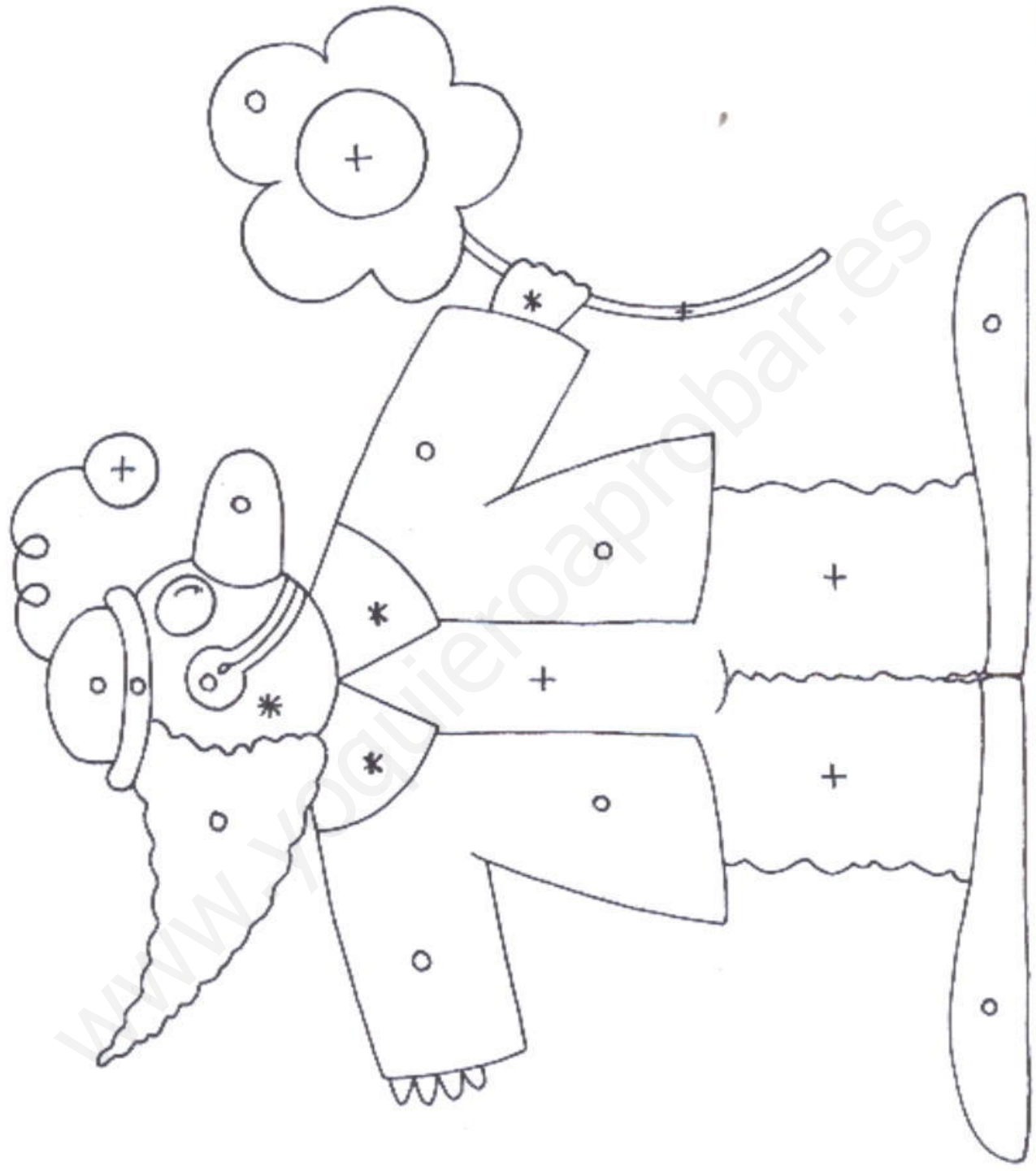

www.wolterioaprebar.es



SEMEJANZAS Y DIFERENCIAS

Pinta del mismo color los objetos que son iguales.

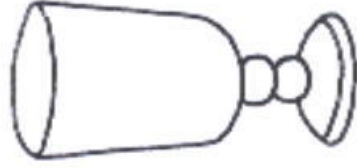
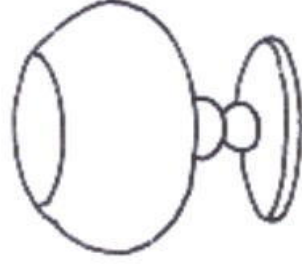
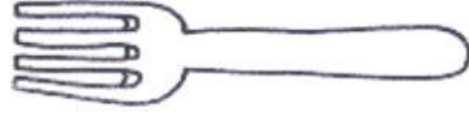
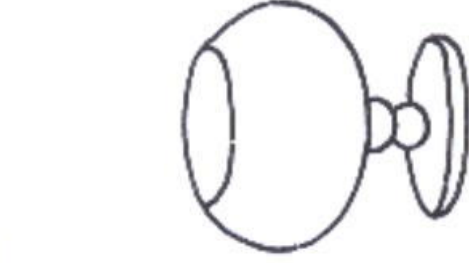



DISTINCIÓN FIGURA-FONDO

Busca la fruta escondida y pinta.

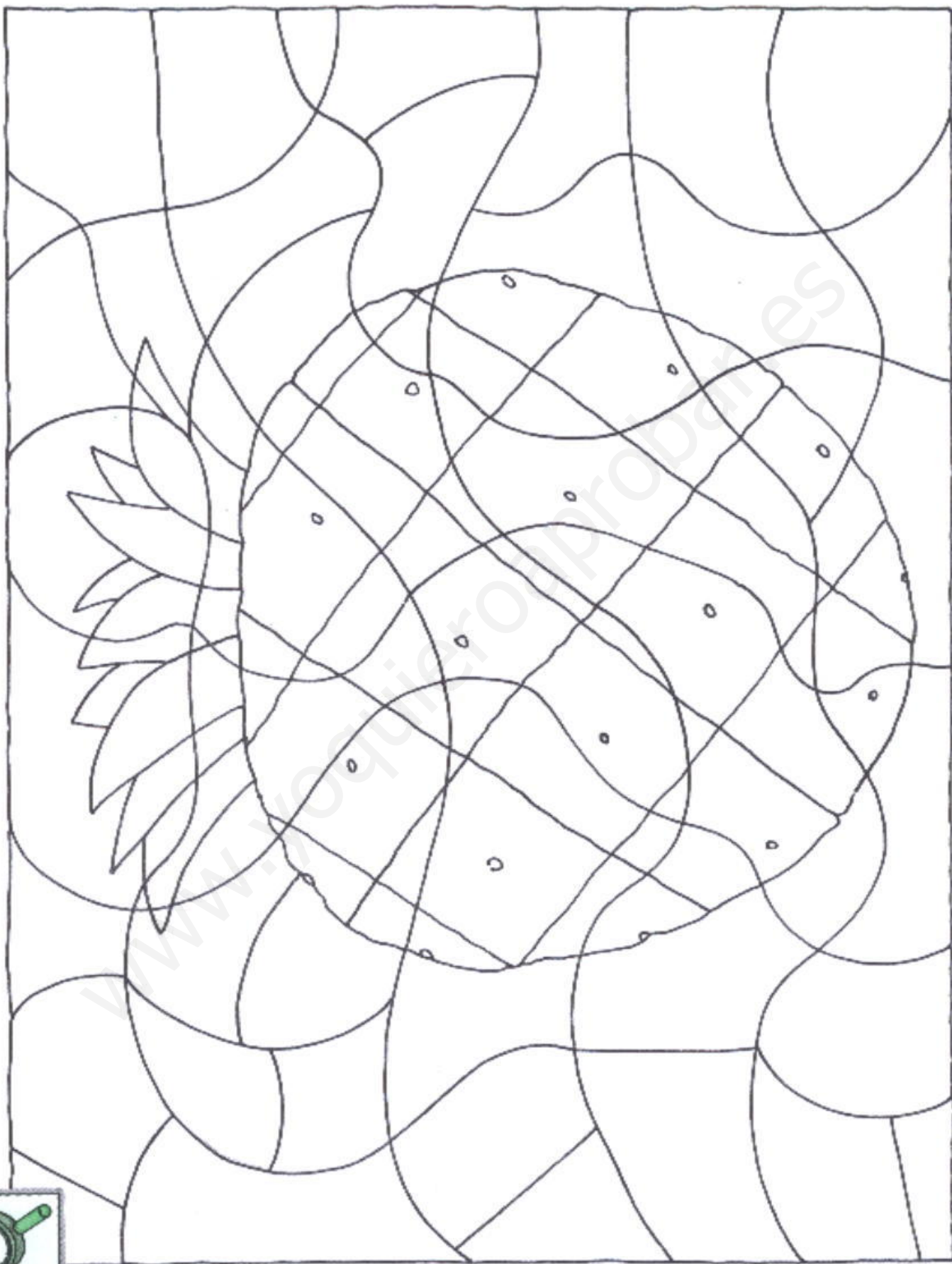



DIBUJOS INCOMPLETOS

Completa los dibujos según el modelo y píntalos.

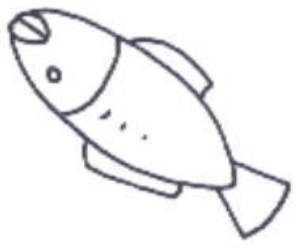
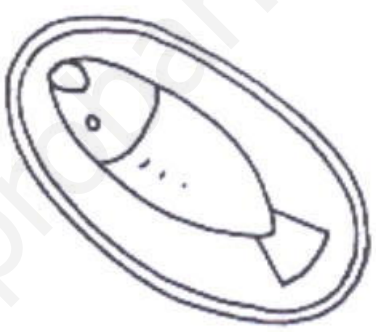
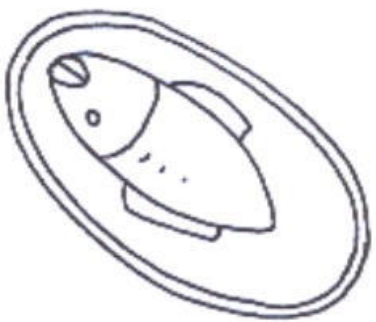
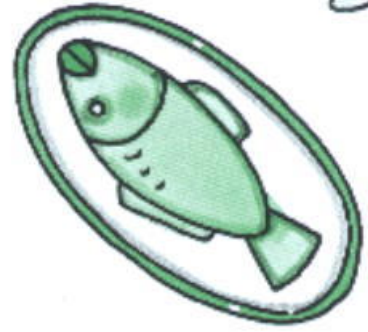
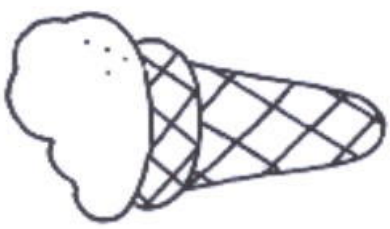
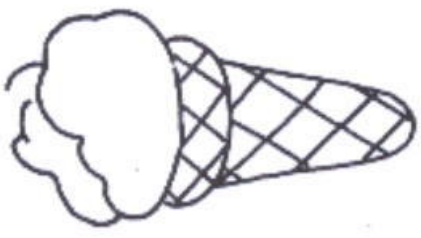
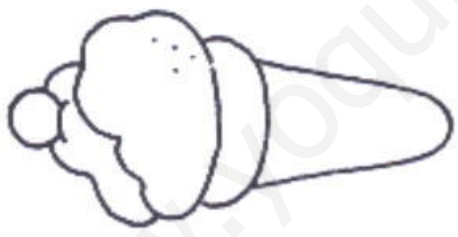
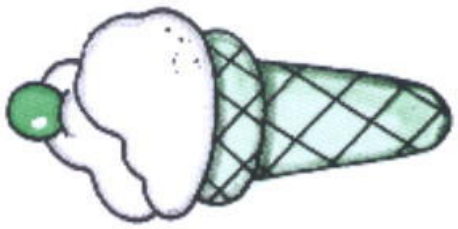

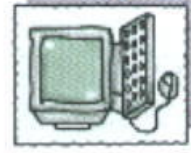

LÍNEAS CRUZADAS

Sigue las líneas y dibuja cada fruta en el lugar que le corresponda. Píntalas.

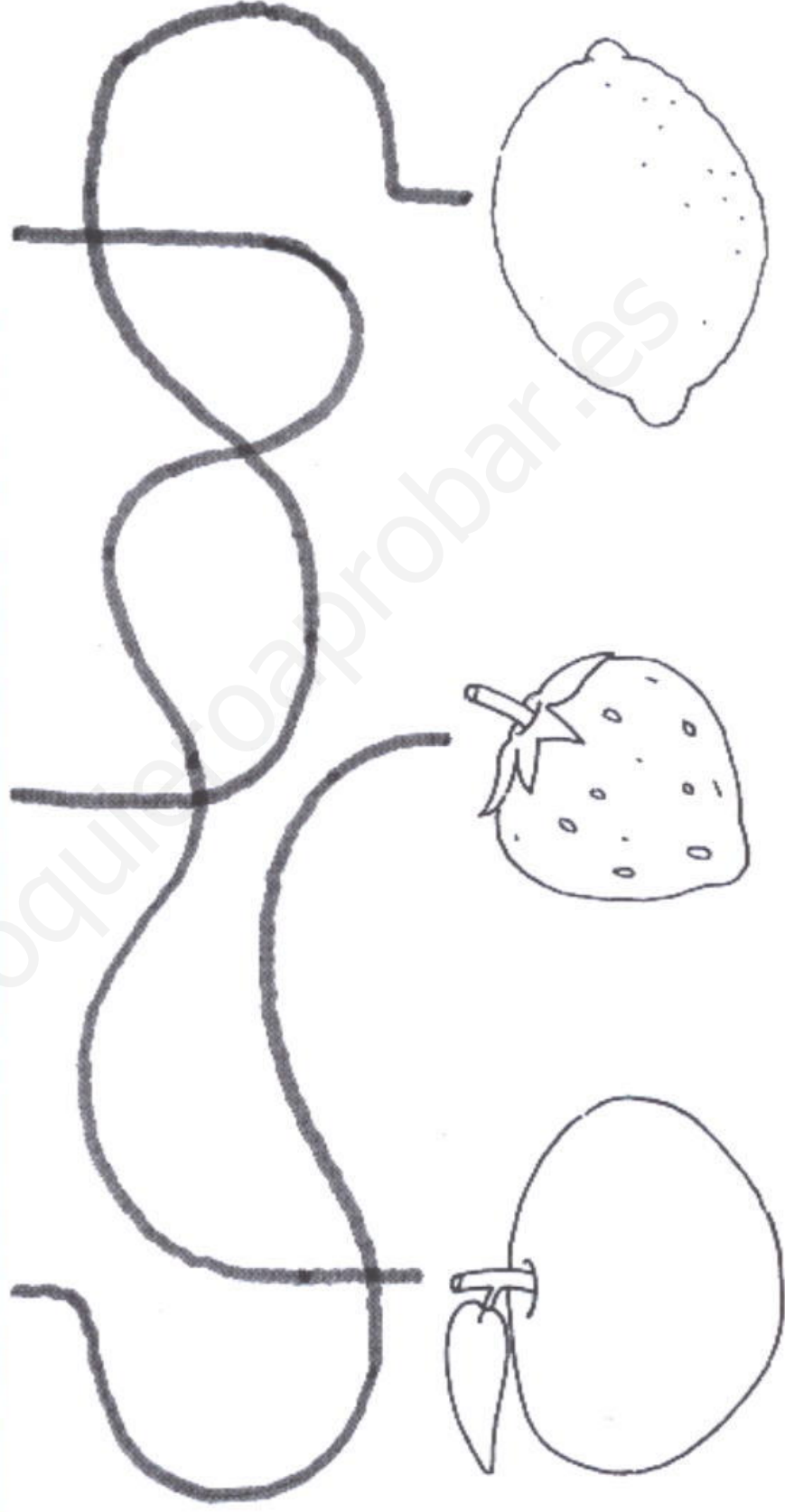



SEMEJANZAS Y DIFERENCIAS

Encierra las figuras que son iguales al modelo y tacha las diferentes.

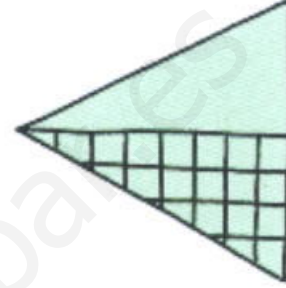
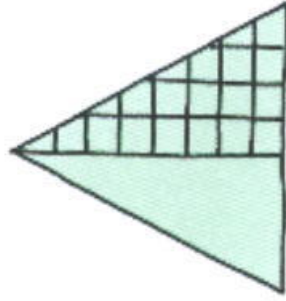
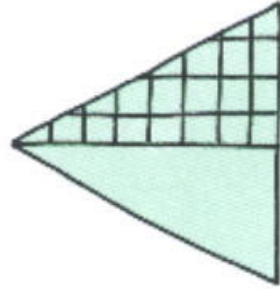
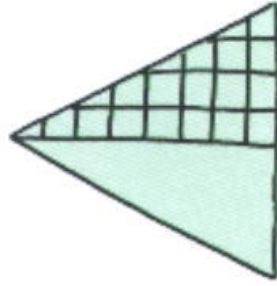
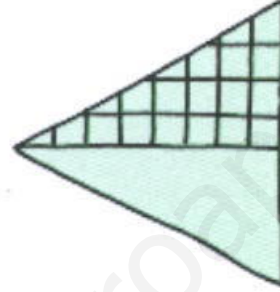
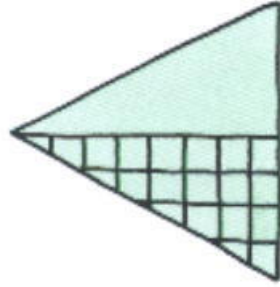
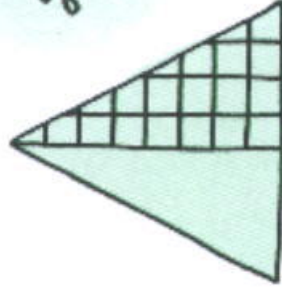
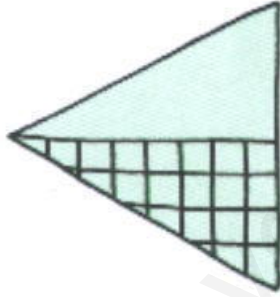
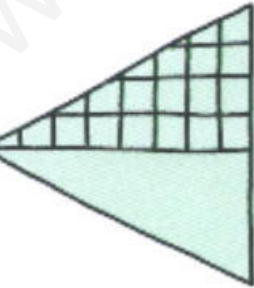
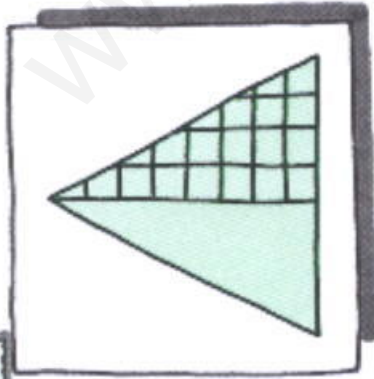



DISTINCIÓN FIGURA-FONDO

Pinta el avión y el barco.

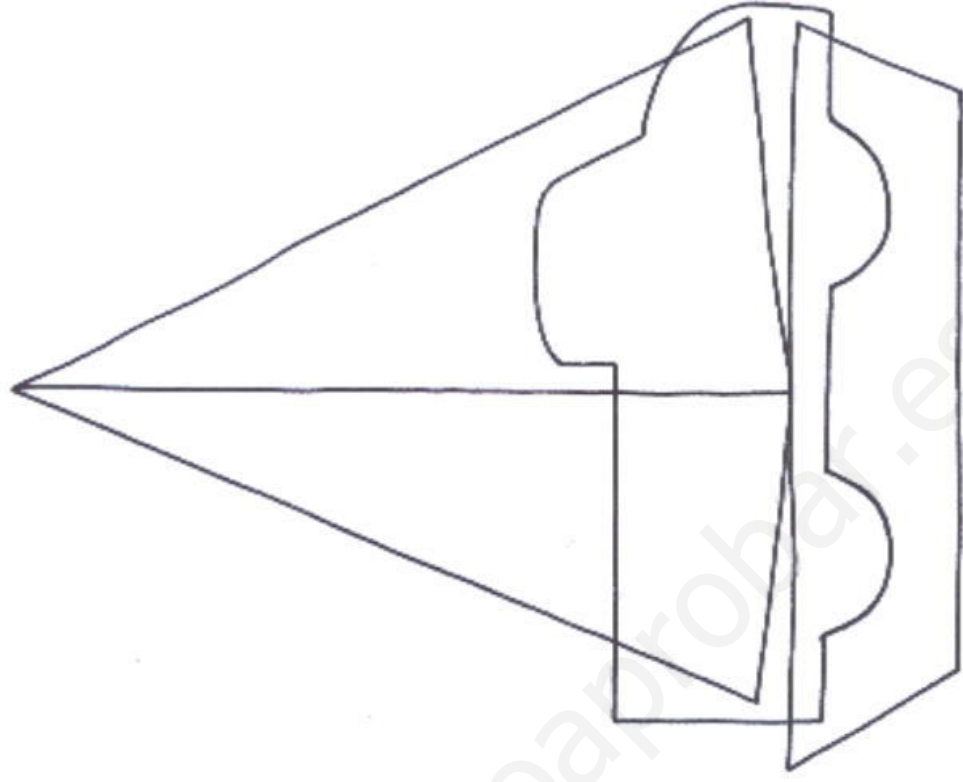
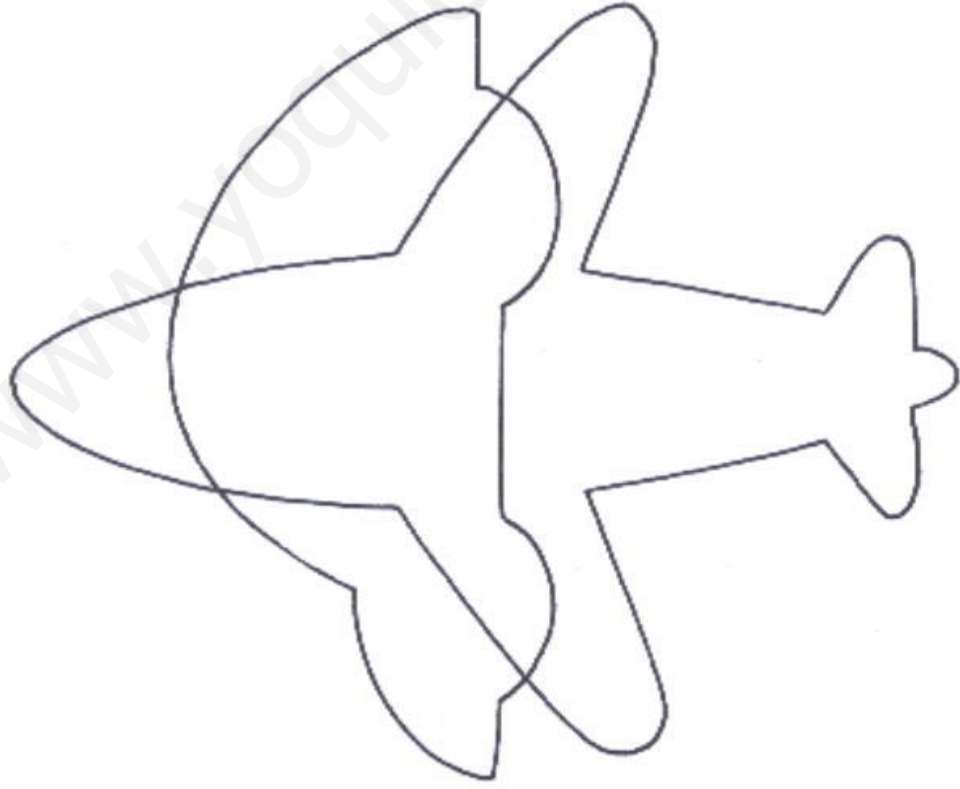



DIBUJOS INCOMPLETOS

Completa los dibujos de abajo como los modelos de arriba.

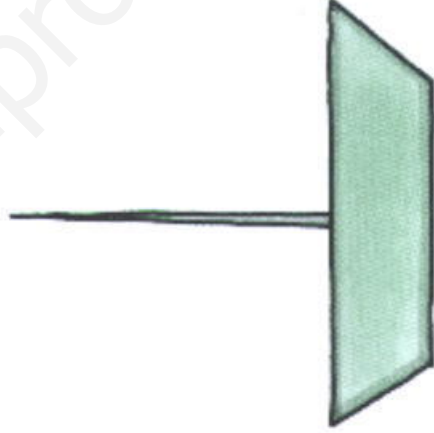
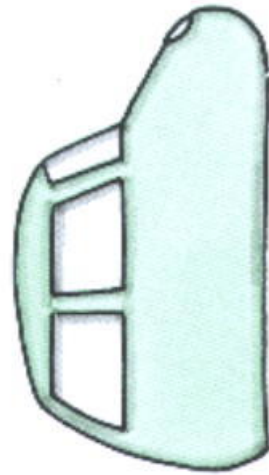
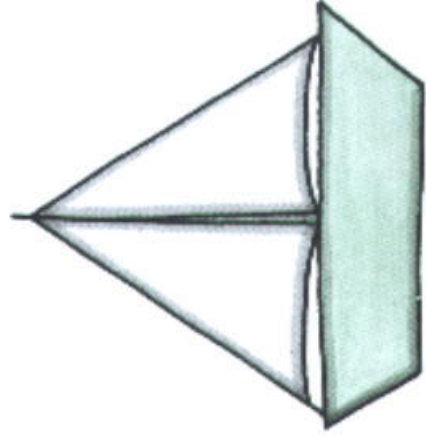
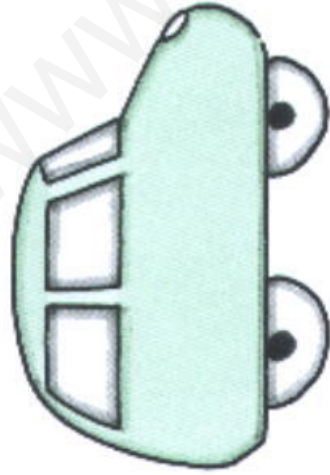



MEMORIZACIÓN DE DIBUJOS

Observa un tiempo estos medios de transporte. Pasa a la página siguiente.

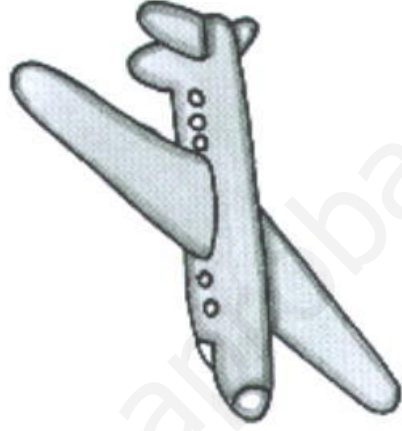
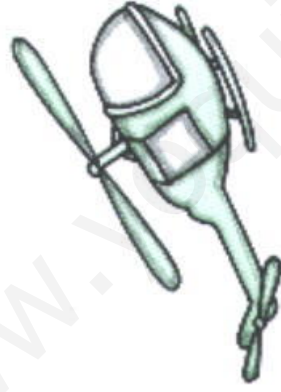

www.quieroair.com/bar.es



MEMORIZACIÓN DE DIBUJOS

Encuentra los dos dibujos de la página anterior y enciérralos.

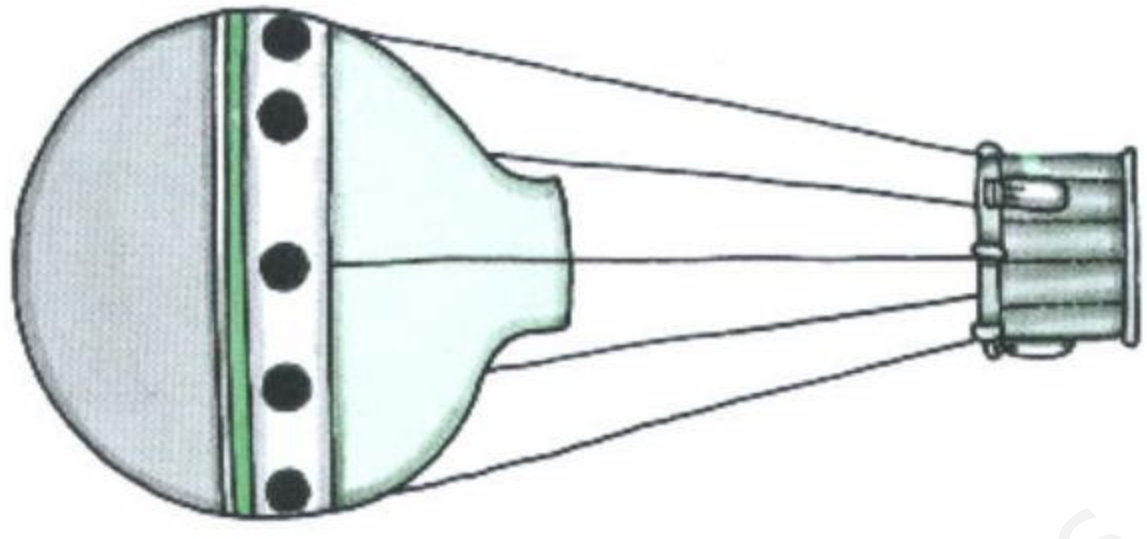
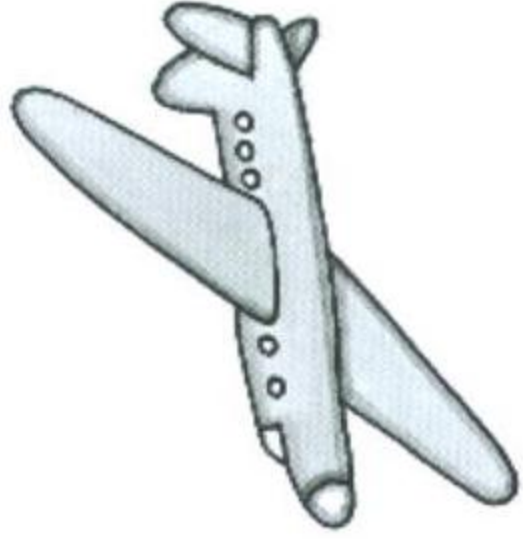
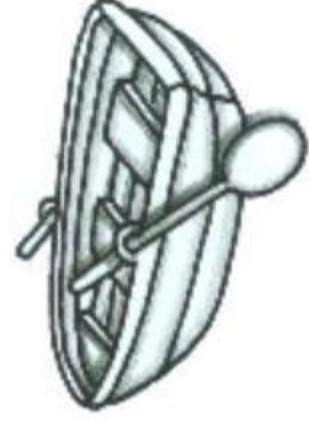
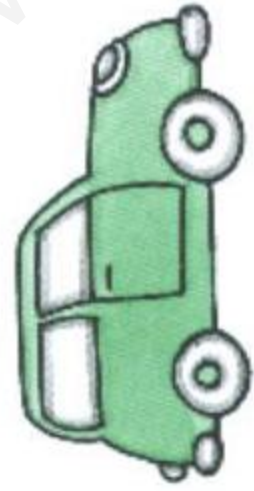

www.yoquieroaprobar.es



RECONOCIMIENTO DE PROPIEDADES

Pinta de color amarillo las señales de tránsito que tienen forma de triángulo, de color azul las cuadradas y de color rojo las redondas.

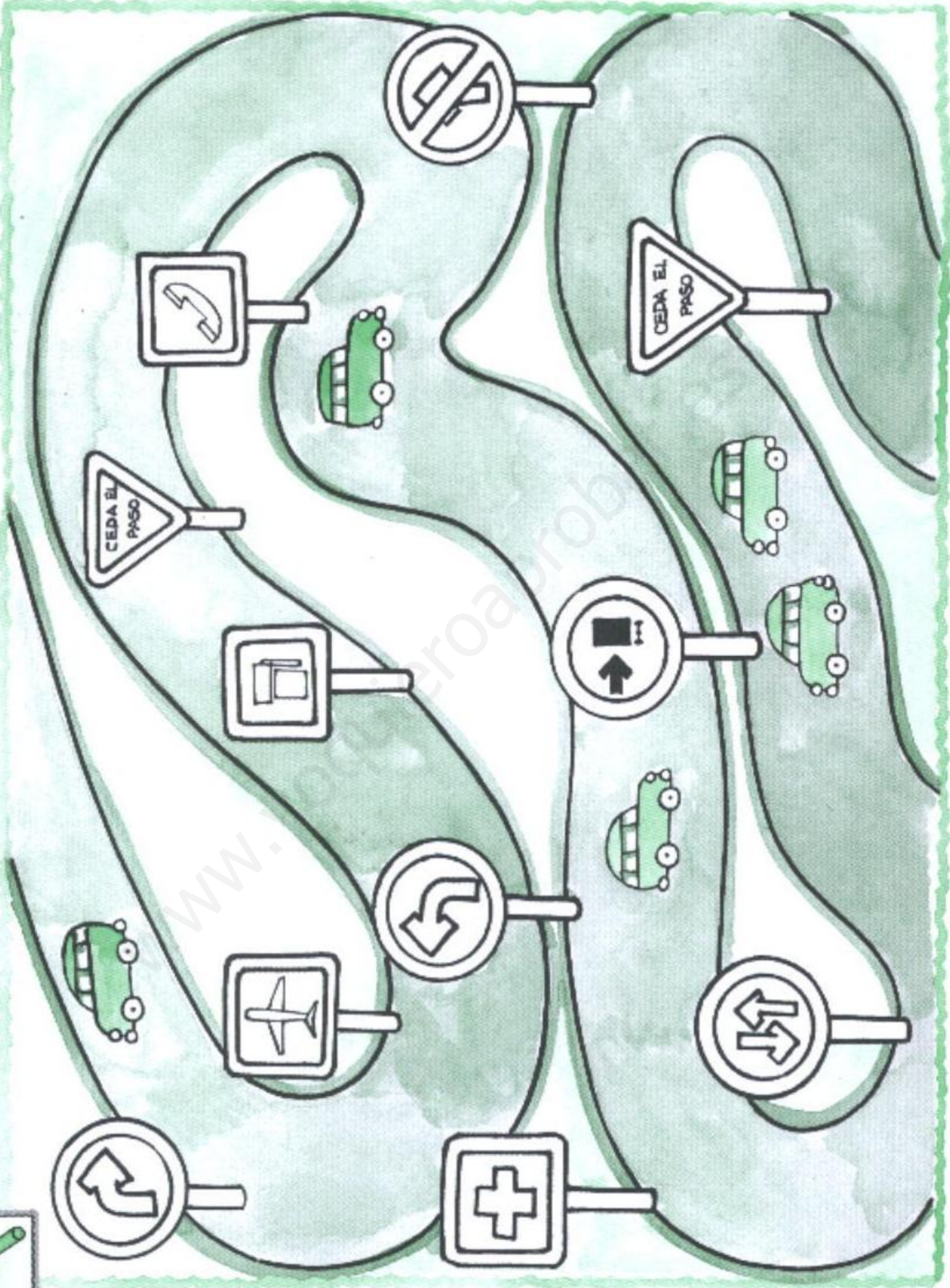



DIBUJOS INCOMPLETOS

A cada dibujo le falta un detalle importante. Dibújasele.

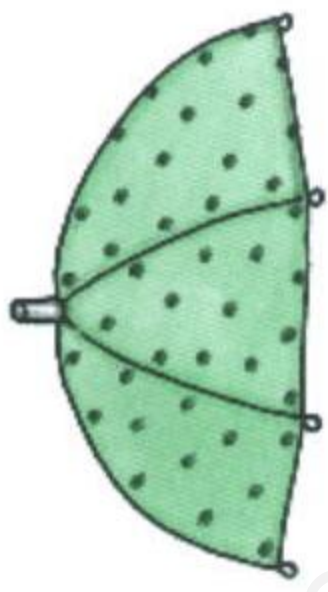
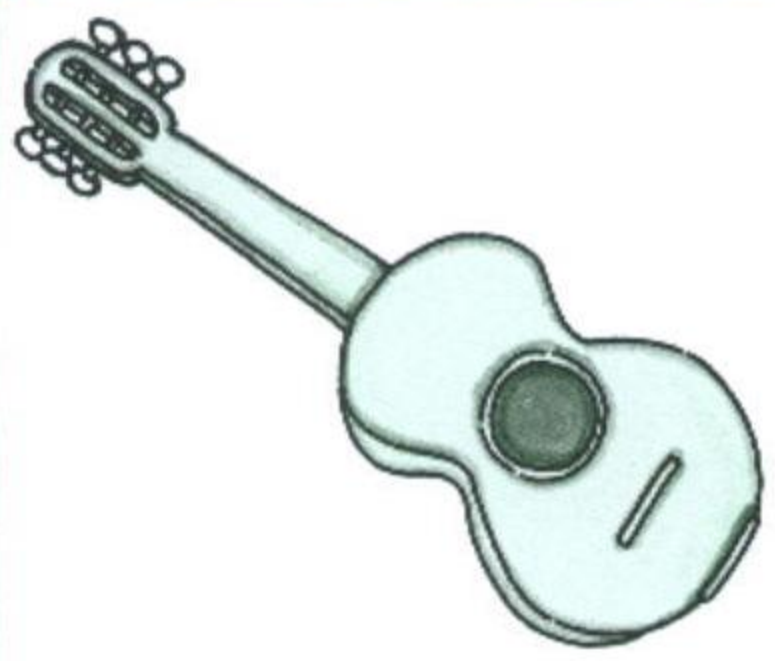
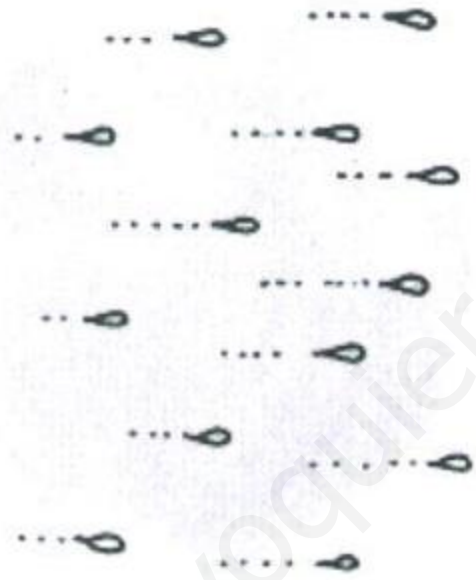
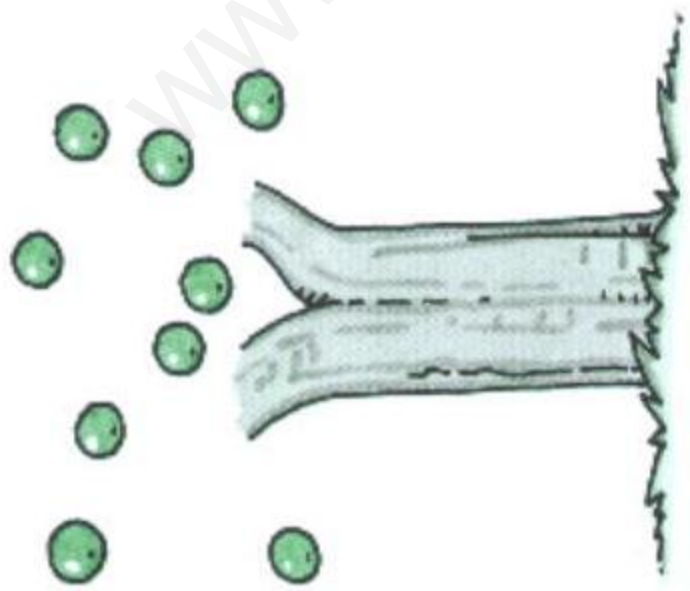



OBJETOS ESCONDIDOS

Busca y pinta: las **chinitas** de color rojo, los **caracoles** de color café y la **manguera** de color naranja.





ASOCIACIÓN DE CLAVES

Pinta el dibujo, según la clave, de color: (1) verde, (2) amarillo.

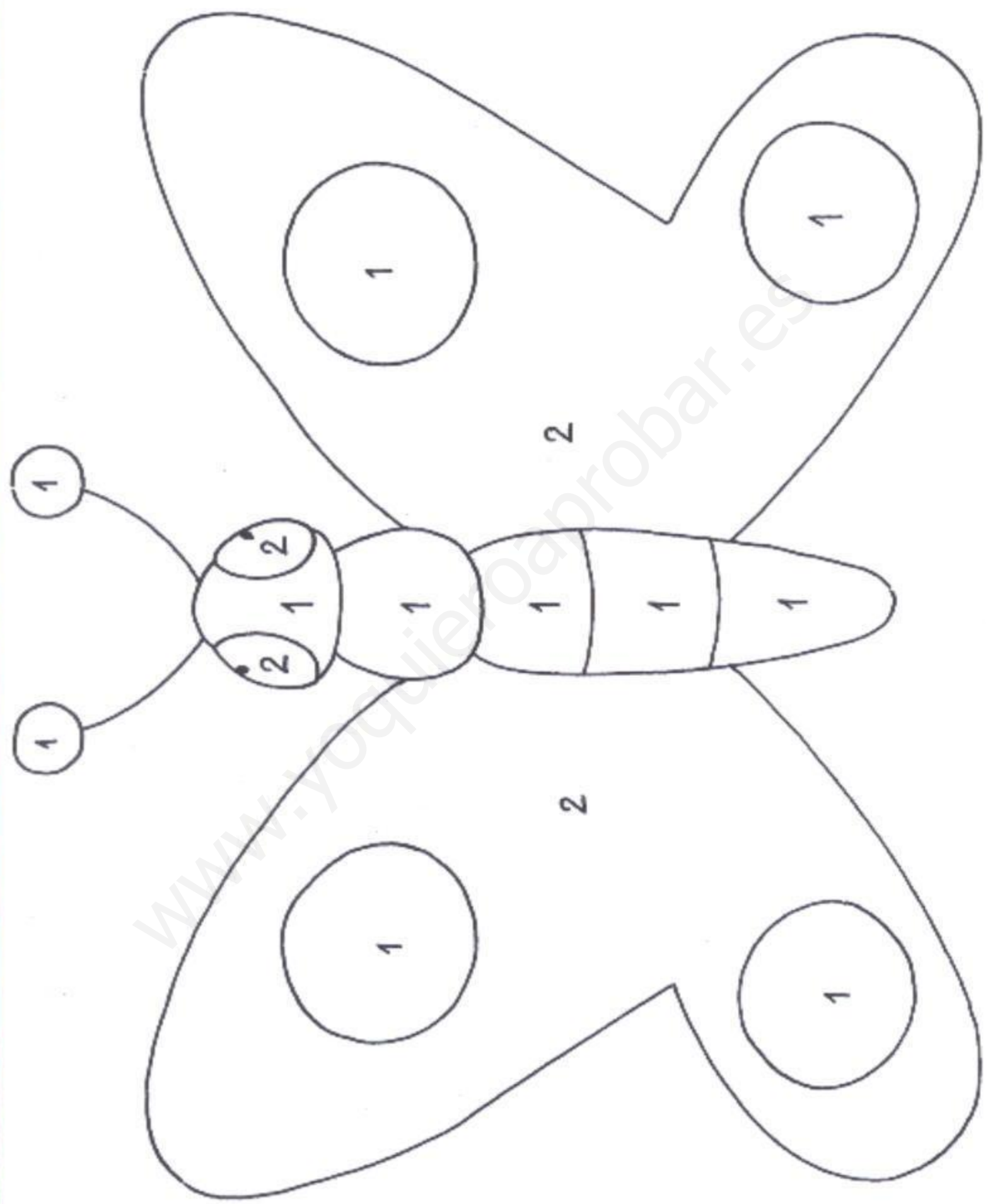

www.yoquieroaprobar.es



MEMORIZACIÓN DE DIBUJOS

Observa el dibujo y reproducélo en la parte de atrás de la hoja.

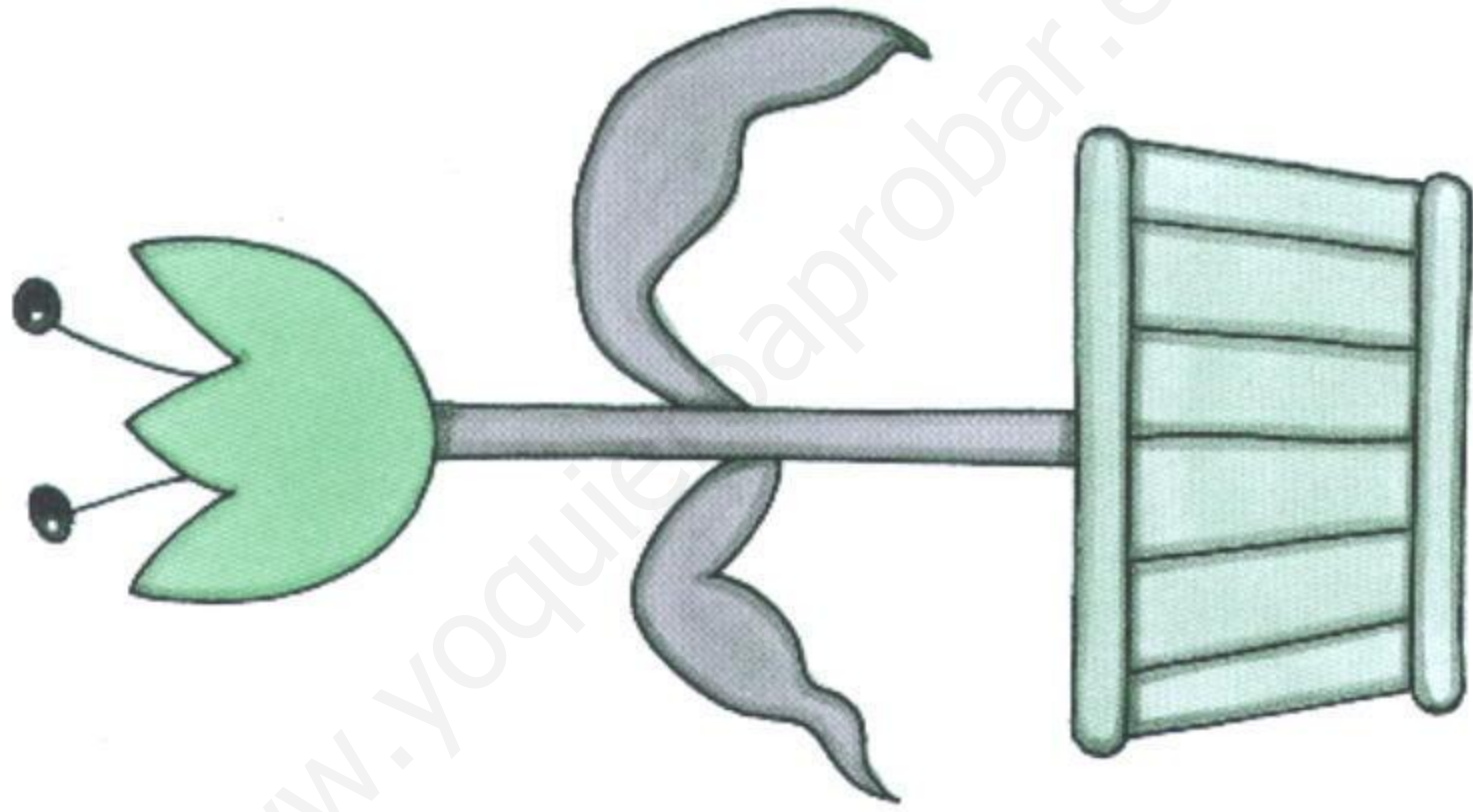

www.yoquieroaprobar.es



SEMEJANZAS Y DIFERENCIAS

Tacha los dibujos diferentes al primero.

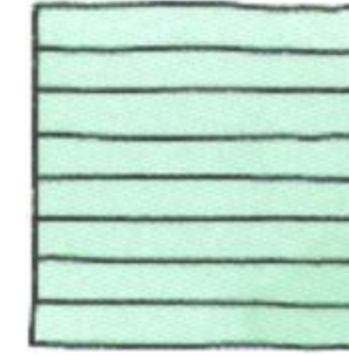
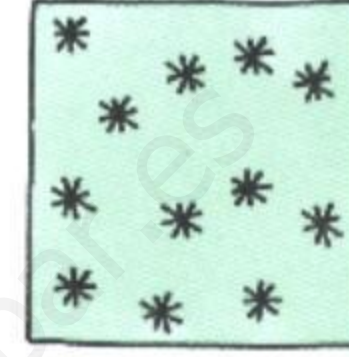
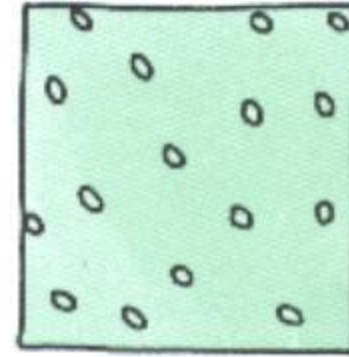
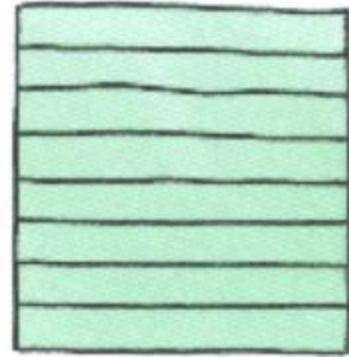
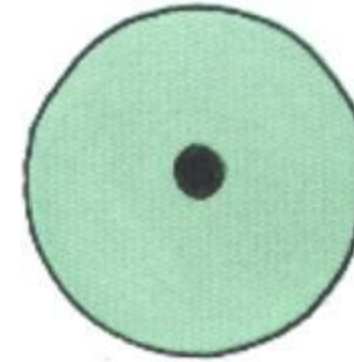
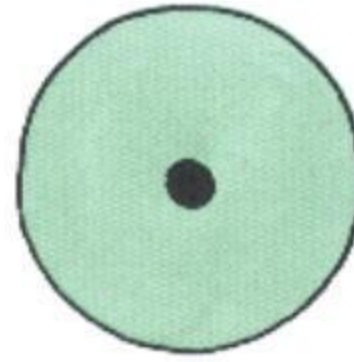
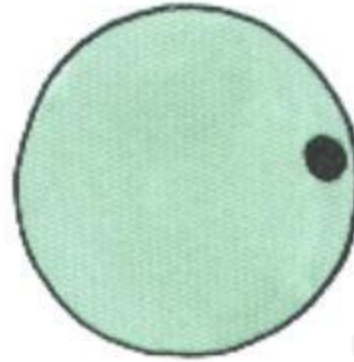
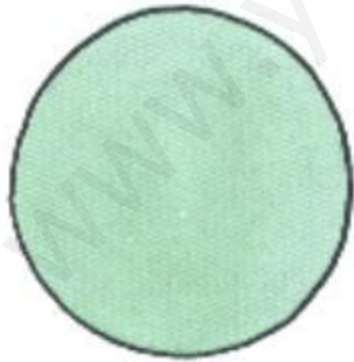
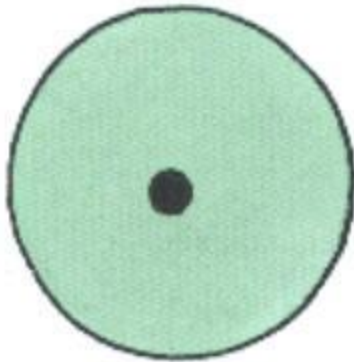



DIBUJOS INCOMPLETOS

Une con flechas cada animal con la parte que le falta. Completa los dibujos.

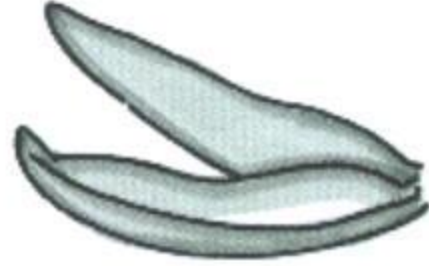
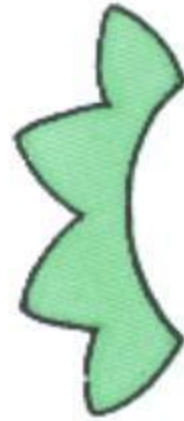
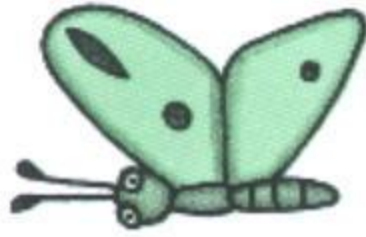

OBJETOS ESCONDIDOS

Observa el dibujo y pinta los monos y los pájaros.



DISTINCIÓN FIGURA-FONDO

Pinta, según la clave: (+) naranja, (-) verde, y encuentra el dibujo escondido.

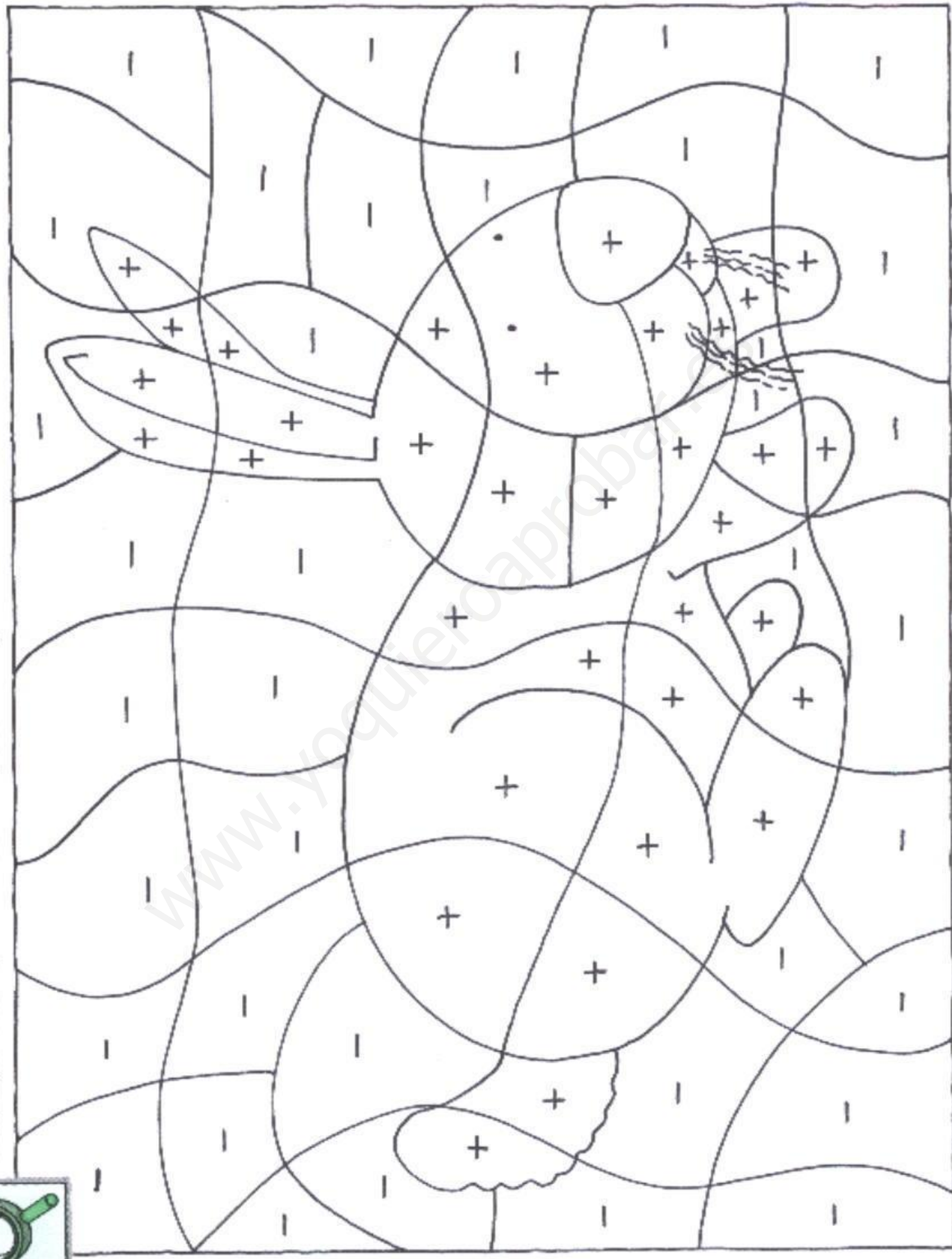

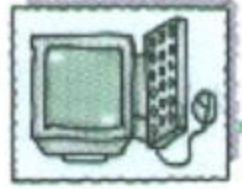

ASOCIACIÓN DE CLAVES

Pinta el dibujo, según la clave, de color: (1) naranja, (2) café.

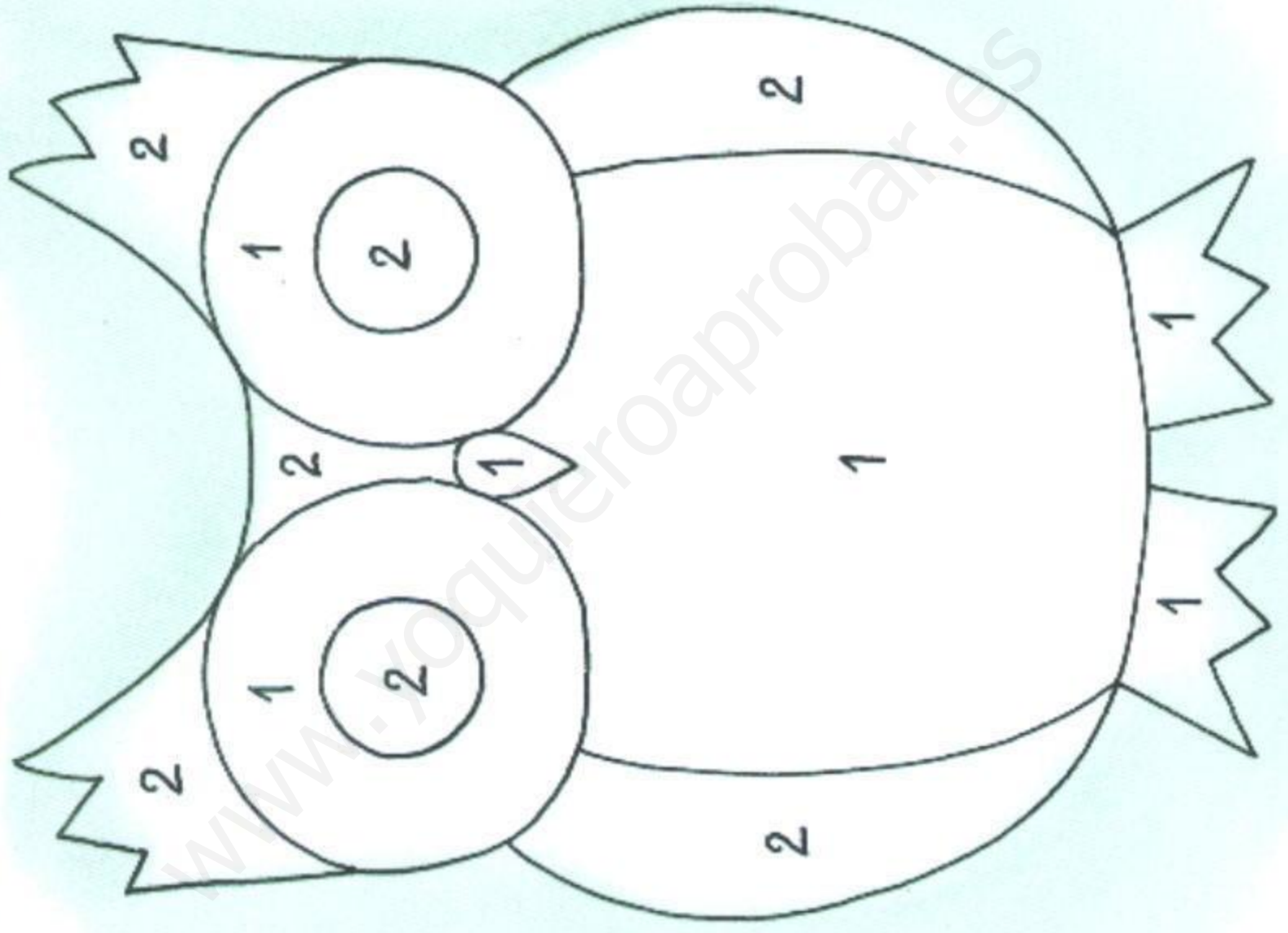



RECONOCIMIENTO DE PROPIEDADES

Pinta los **cuadrados** de color azul, los **círculos** de color rojo y los **triángulos** de color verde.

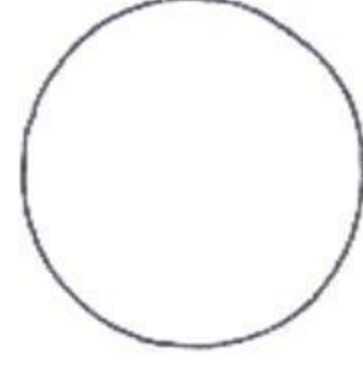
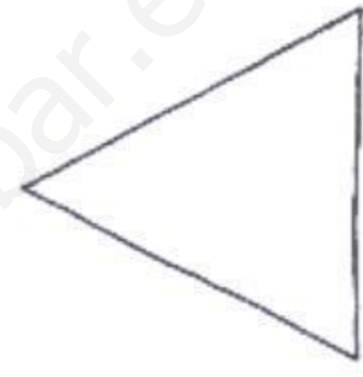
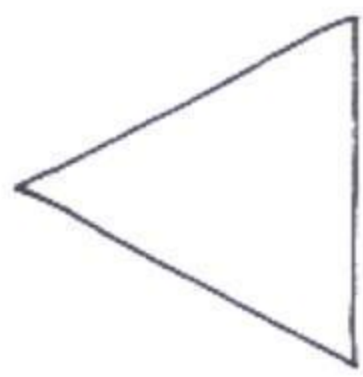
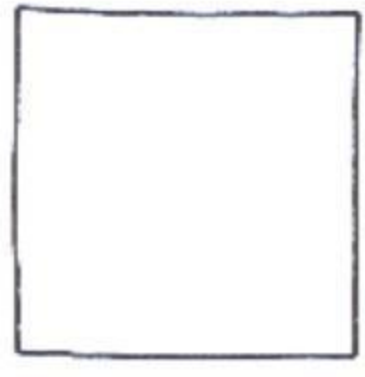
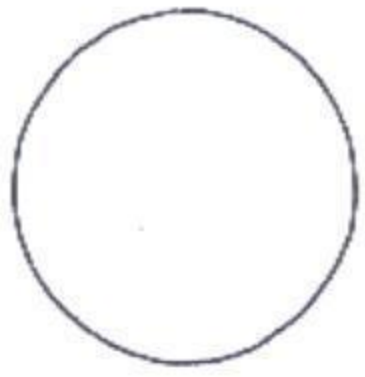
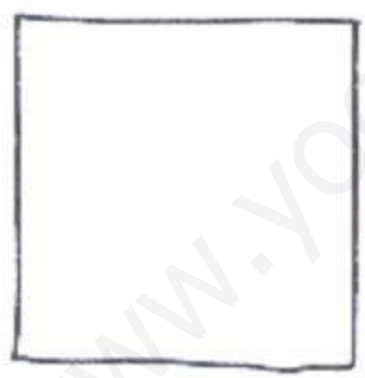
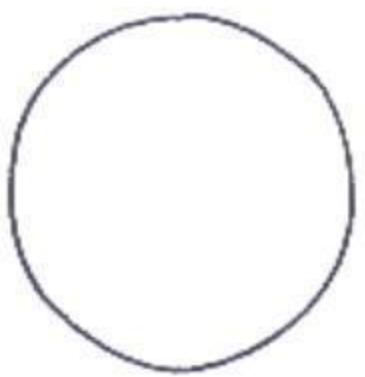

www.yoquieroaprobar.es



SEMEJANZAS Y DIFERENCIAS

Completa los baldes y los barcos igual que el modelo.

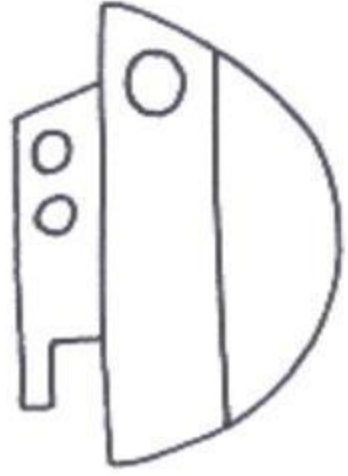
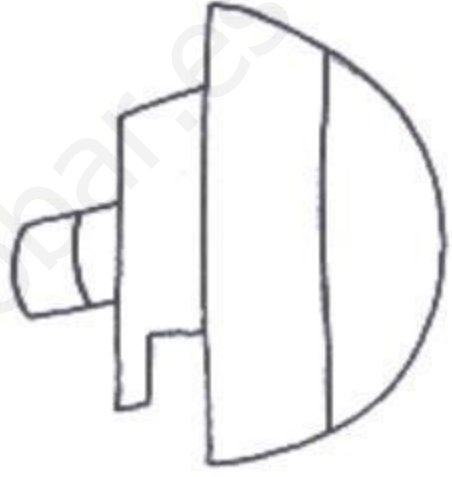
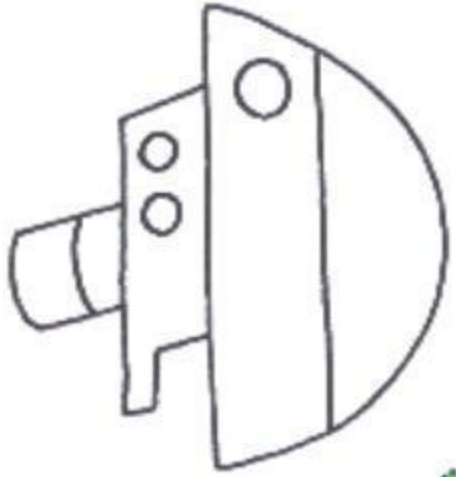
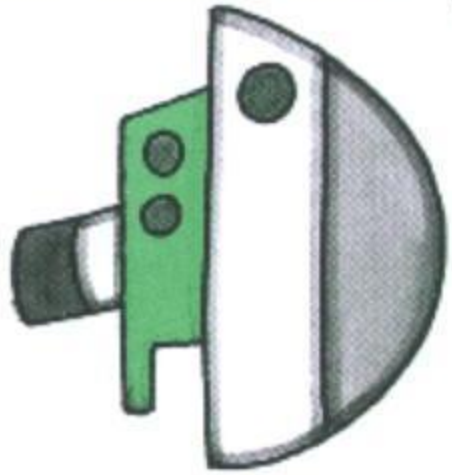
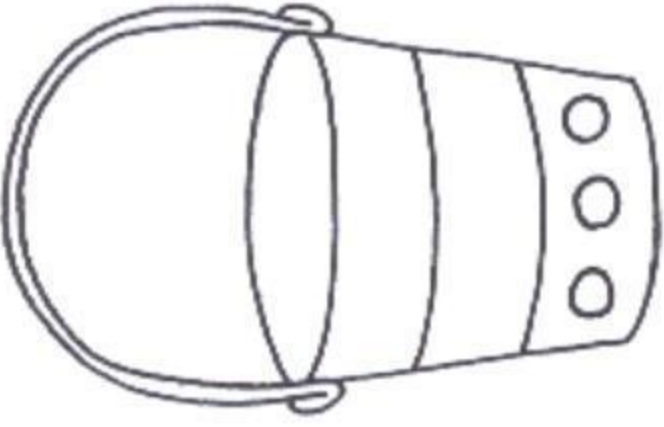
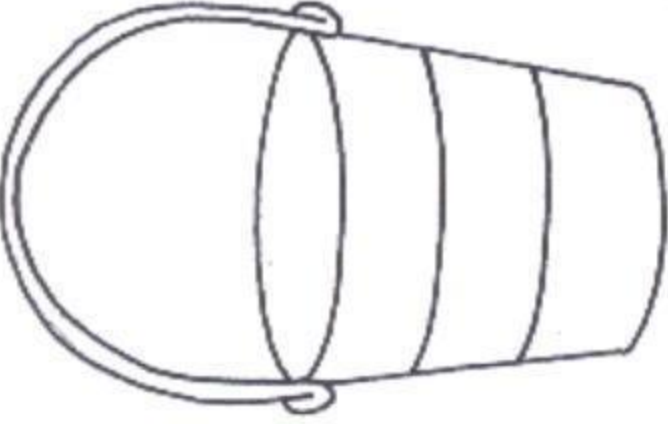
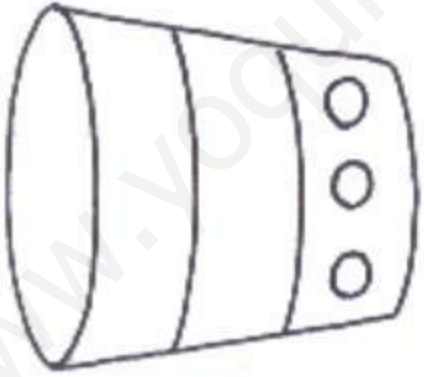
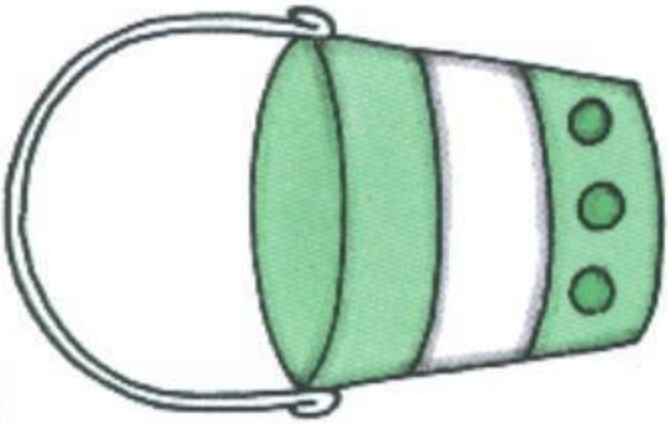

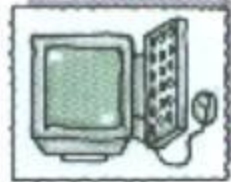

MEMORIZACIÓN DE DIBUJOS

Observa los dibujos. Dobra la hoja por la mitad para no verlos y dibuja los objetos en el recuadro de la derecha.

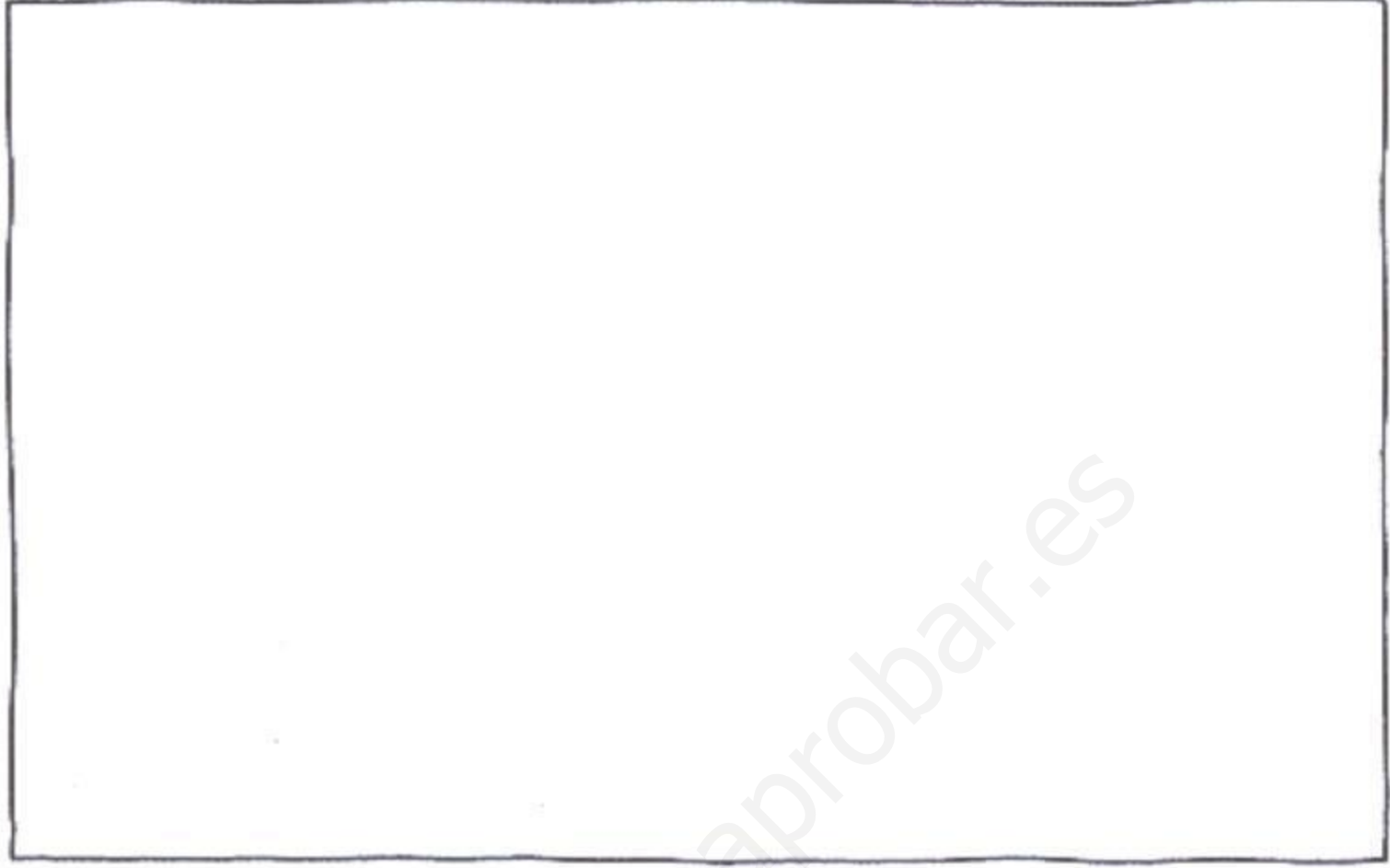
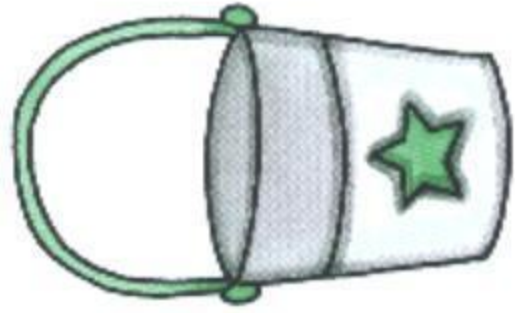
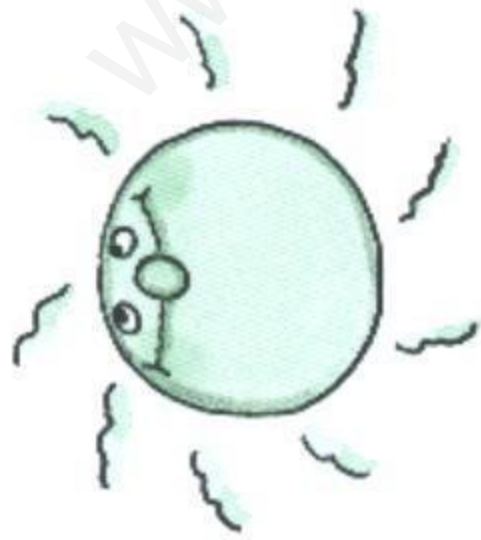

www.yoquieroaprobar.es



SEMEJANZAS Y DIFERENCIAS

Pinta el modelo y tacha los dibujos diferentes.

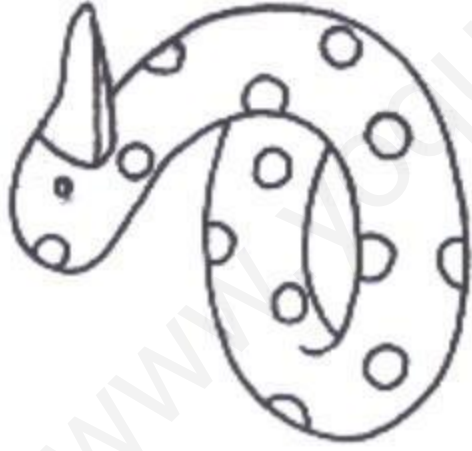



ASOCIACIÓN DE CLAVES

Raya el dibujo según la clave.

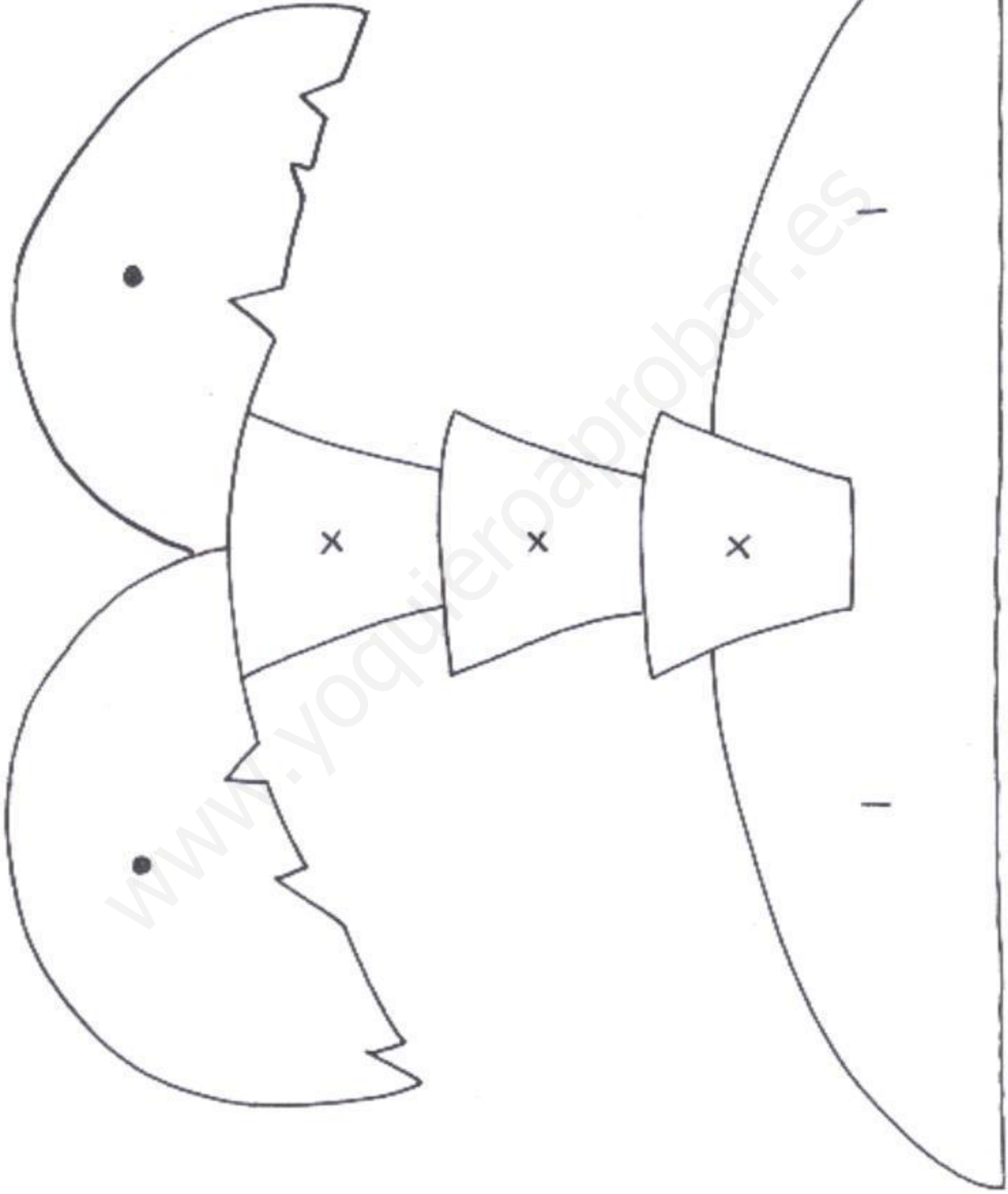
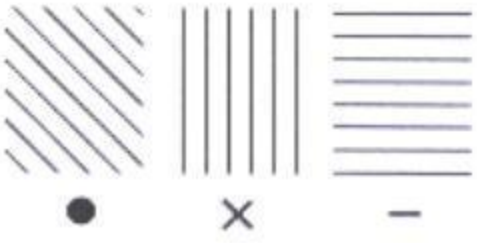



OBJETOS ESCONDIDOS

Busca en la escena los objetos del recuadro y enciérralos.

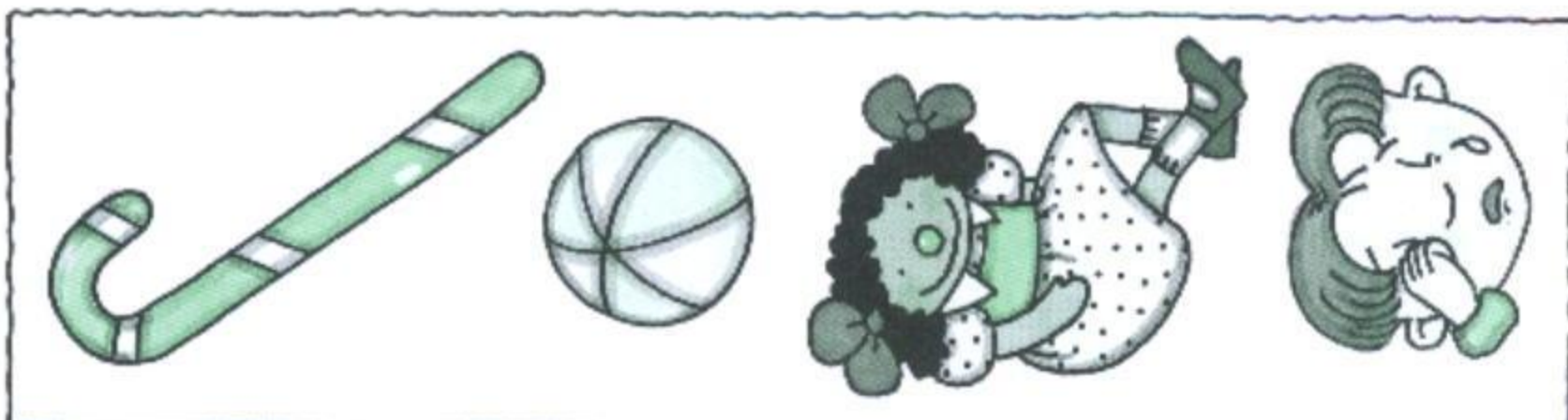



RECONOCIMIENTO DE PROPIEDADES

Traza puntos en las **estrellas** y las **esferas** según el modelo. Completa el árbol dibujando **estrellas** y **esferas**.

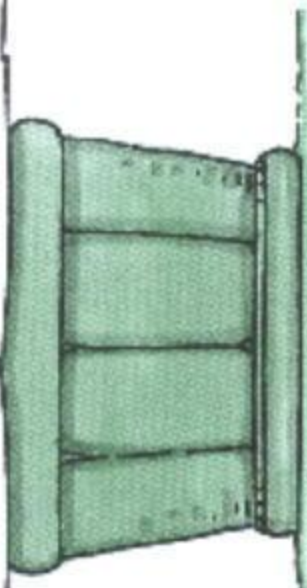
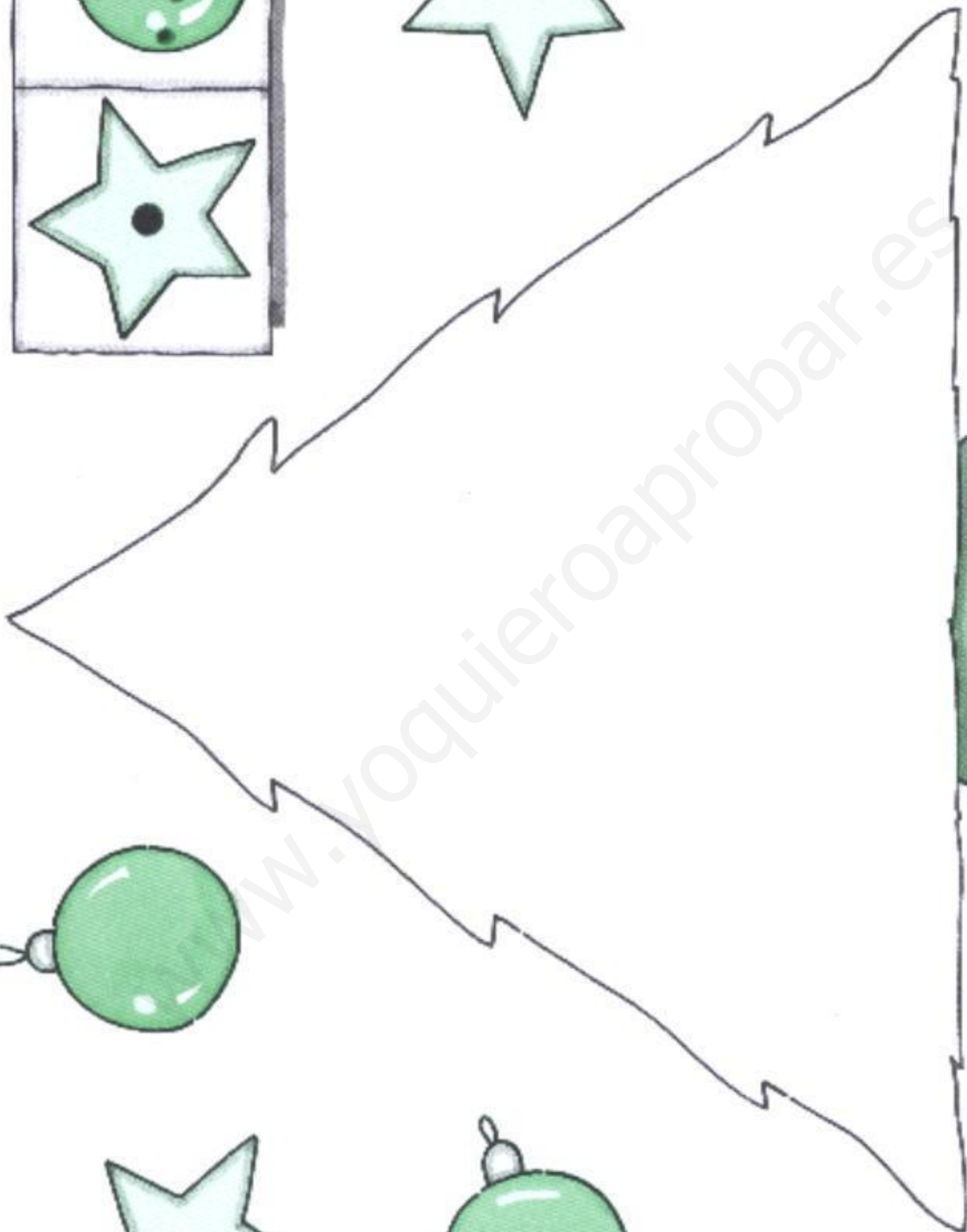
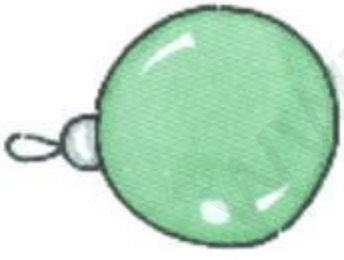
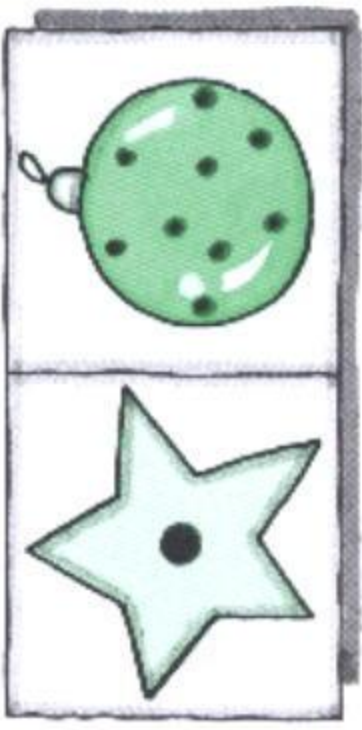

www.yoquieroaprobar.es



LÍNEAS CRUZADAS

Sigue las líneas y dibuja cada una de las figuras en el lugar que corresponda. Píntalas.

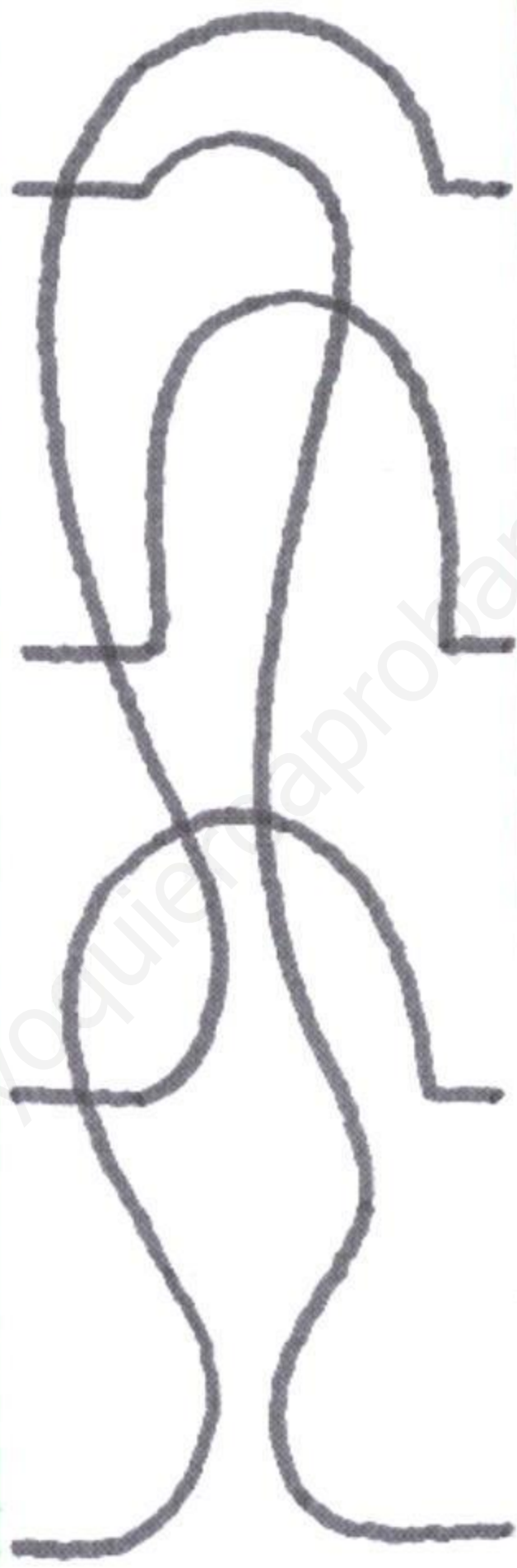
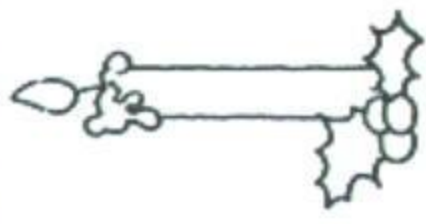
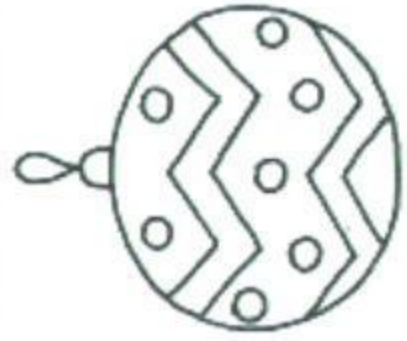
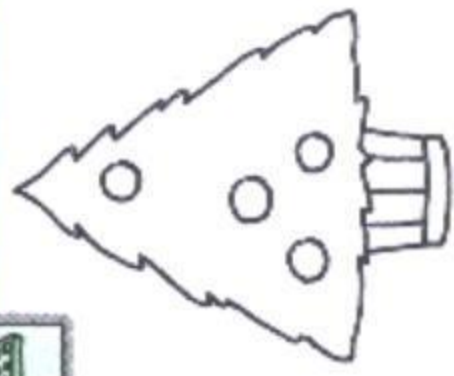

www.loquienapropar.es

DIBUJOS INCOMPLETOS

Busca y dibuja lo que les falta a los personajes del nacimiento.

