







SUMMER ACTIVITIES 3°EP



Name: _____

PERSONAL PRONOUNS

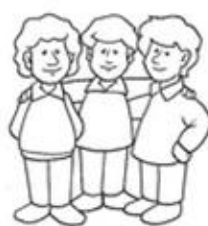
1 Write the personal pronouns under the picture.

| | | | |
|---|---|--|--|
|  yo |  él |  ella |  tú |
| | | | |
|  Ello |  Nosotros |  Vosotros |  Ellos |
| | | | |

2 Write the personal pronouns

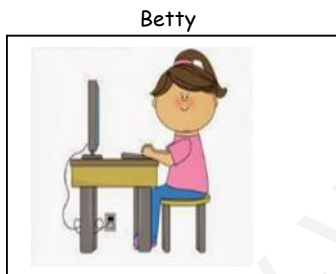

_____ is playing on the computer.



_____ are playing in the sandbox.



_____ am doing a puzzle.

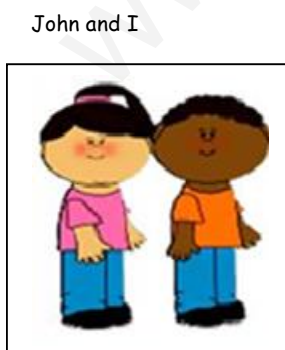

_____ are friends.

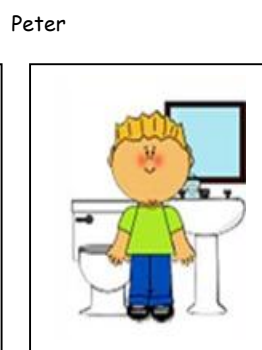

_____ is in the bathroom .

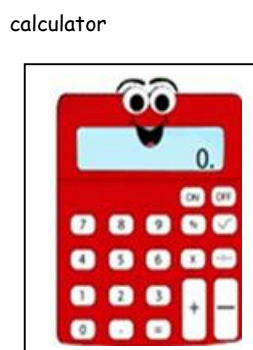

_____ is red.



_____ are going to school.

Possessive Adjectives

1. My dad is a writer.
It is _____
computer.



2. Jacob is washing
_____ hands.
They are
very dirty.



I-my We-our
You-your They-their
He-his
She-her



3. Ann is baking
cookies for

mother.



4. They put _____
keys near the
door.



5. I'm 10 today. It is

birthday.



6. Why is _____ mum?
She is an
architect.



7. Could you give me

telephone
number?



8. Nick is late
because he missed

bus.



9. I can't go out. I
must do _____
homework.



10. Lucie loves _____
new kitten.
It is so
funny!



11. Tom brushes _____
_____ teeth twice
every day.



12. They are twins.
_____ names
are Tom
and Philip.

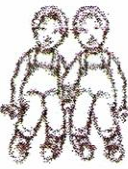

13. Where's Karol?
She is in _____
room.



14. It is my dog and
_____ name is
Barky.



AFFIRMATIVE NEGATIVE INTERROGATIVE

I am
You are

He is
She is
It is

We are
You are
They are

I am not
You are not

He is not
She is not
It is not

We are not
You are not
They are not

Am I?
Are you?

Is he?
Is she?
Is it?

Are we?
Are you?
Are they?



Complete the sentences with affirmative form of verb to be.

- 1 John _____ my best friend.
- 2 She _____ French.
- 3 My cat _____ brown.
- 4 I _____ a good student.
- 5 Billy _____ a doctor.
- 6 Ryan _____ a policeman.
- 7 They _____ in the kitchen.
- 8 I _____ happy.
- 9 He _____ 6 years old.
- 10 We _____ at school.
- 11 My dog _____ black.
- 12 It _____ sunny.
- 13 You _____ old.
- 14 I _____ an actor.

Complete the sentences with negative form of verb to be.

- 1 Bella _____ my sister.
- 2 She _____ my mother.
- 3 I _____ English.
- 4 Kevin _____ French.
- 5 Bill _____ at school.
- 6 We _____ German.
- 7 He _____ a boy.
- 8 That car _____ red.
- 9 They _____ at school.
- 10 It _____ sunny today.
- 11 You _____ American.
- 12 I _____ sad.

Write the sentences in the interrogative form

- 1) you are at school → _____
- 2) he is English → _____
- 3) they are happy → _____
- 4) I am tall → _____
- 5) she is short → _____
- 6) they are sad → _____
- 7) it is a dog → _____



55 Write the third person singular.

- | | | |
|--------------------------------------|---------------------|---------------------|
| 1. I teach - He .. <i>teaches</i> .. | 4. They fly - It .. | 7. You like - He .. |
| 2. We study - He .. | 5. I clean - She .. | 8. I do - She .. |
| 3. You cook - She .. | 6. I buy - He .. | 9. We walk - He .. |

56 Complete the sentences as in the example:

Long Form

- She .. *does not* .. speak Italian.
- They .. go to school.
- We .. swim very well.
- He .. watch TV every day.
- You .. live in England.

Short Form

- She .. *doesn't* .. speak Italian.
 They .. go to school.
 We .. swim very well.
 He .. watch TV every day.
 You .. live in England.

57 Write what these people "do" or "don't do".



| | study hard | ride a bicycle | swim very well | listen to the radio |
|------------------------|------------|----------------|----------------|---------------------|
| Penny | ✓ | | ✓ | |
| Bob | | ✓ | ✓ | ✓ |
| Don & Alice | | ✓ | | ✓ |
| You | | | | |

- Penny .. *studies hard and swims very well but she doesn't ride a bicycle or listen .. to the radio.* ..
- Bob ..
- Don and Alice ..
- I ..

1 Choose the correct option.

1



- a science lab
- b music room

3



- a cafeteria
- b headmaster's office

5

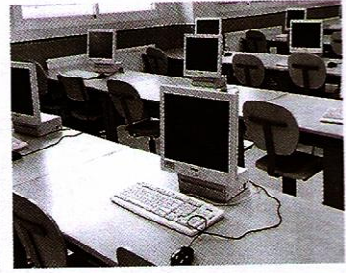

- a toilets
- b computer room

2

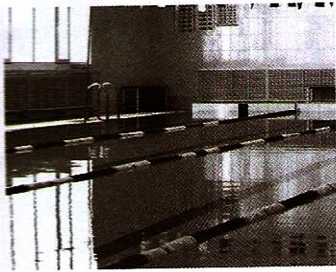

- a teacher's room
- b swimming pool

4

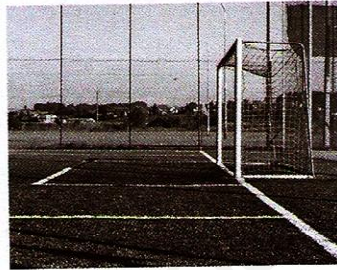

- a classroom
- b football field

6



- a playground
- b gym

2 Complete the sentences.

gym

headmaster's office

~~cafeteria~~

science lab

football field

1 People eat in the cafeteria.

2 Bad students go to the _____.

3 You can do an experiment in the _____.

4 You play football in the _____.

5 You play basketball in the _____.

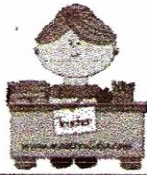

DAILY ROUTINE AND SIMPLE PRESENT

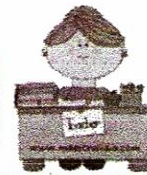

READ AND MATCH

- 1-HAVE LUNCH
- 2-GET UP
- 3-GO TO SCHOOL
- 4-GO TO BED
- 5-COME BACK HOME
- 6-PLAY
- 7-START SCHOOL
- 8-WATCH T.V
- 9-DO THE HOMEWORK

2) WRITE THE 3RD PERSON OF THE VERBS:

DRINK = HE DRINKS GO = HE _____ READ = HE _____

STUDY = HE _____ PLAY = HE _____ WATCH = HE _____

SING = HE _____ SLEEP = HE _____ EAT = HE _____

3) WRITE THE NEGATIVE AND INTERROGATIVE FORMS OF THE SENTENCES:

1) YOU PLAY TENNIS IN THE AFTERNOON

NEG _____

INT _____

2) HE DRINKS MILK FOR BREAKFAST

NEG _____

INT _____

3) THEY STUDY ENGLISH AT SCHOOL

NEG _____

INT _____

4) SHE GOES TO SCHOOL BY BUS

NEG _____

INT _____

Telling the time

What time is it?

It's
four o'clock.
half past four.
a quarter to five.

1 Read and draw the times.

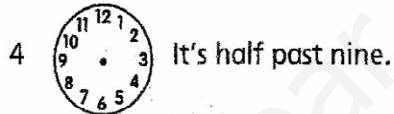
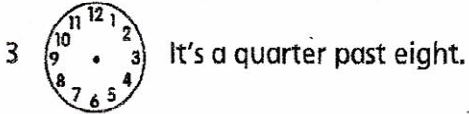
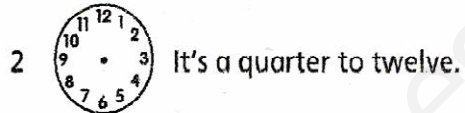

2 Look and write the times.



1 It's half past two.

2 _____

3 _____

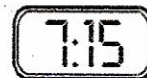

4 _____

5 _____

6 _____

3 Write the questions and answers.

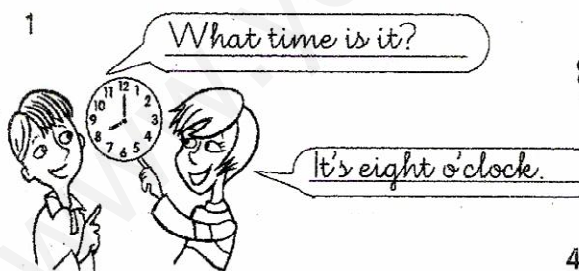
1 

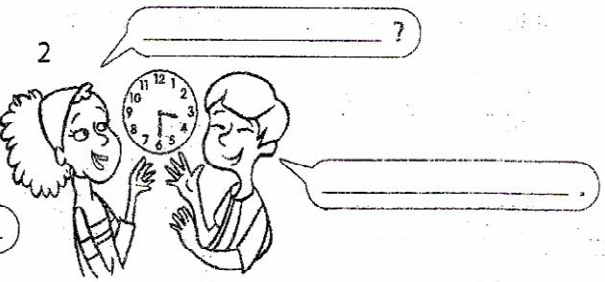
2 

3 

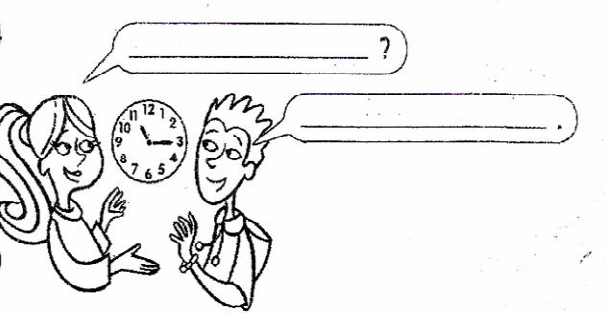
4 

WHAT TIME IS IT?

Look, read and write. Use:

*It's one o'clock.
It's half past four.
It's twenty to nine.*

*It's five to five.
It's ten o'clock.
It's six o'clock.*

*It's twenty past two.
It's ten past eleven.
It's half past nine.*

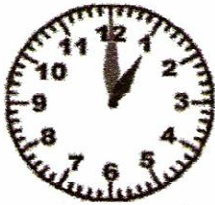

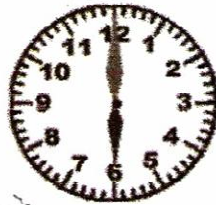

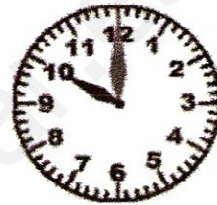



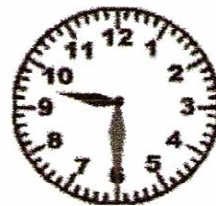





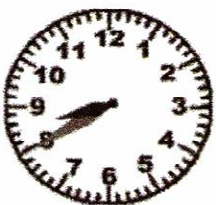



1 Match.

| | | |
|-----------------|-------------|-------------------|
| play volleyball | go running | play table tennis |
| go skiing | go swimming | go ice-skating |



1 go swimming



2 _____



3 _____

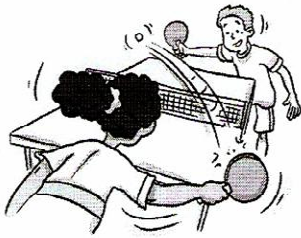

4 _____

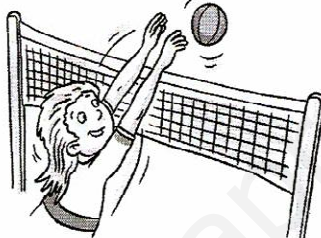





5 _____

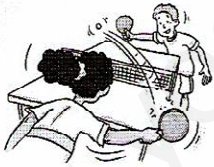

6 _____

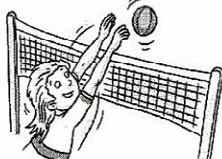
2 Write.

| | | | |
|---|--|--------------------------------|---|
|  | Monday play <u>table tennis</u> | Thursday go _____ |  |
|  | Tuesday go _____ | Friday play _____ |  |
|  | Wednesday go _____ | Saturday go _____ |  |

LOOK AT THE PICTURES, CHOOSE AND THEN WRITE SENTENCES USING HE/SHE/THEY



WHAT IS SHE DOING?

- PLAY THE GUITAR
- PLAYING THE GUITAR
- PLAYS THE GUITAR

WRITE THE SENTENCE



WHAT IS HE DOING?

- DRIVING HIS BIKE
- RIDES HIS BIKE
- RIDING HIS BIKE

WRITE THE SENTENCE



WHAT ARE THEY DOING?

- DANCING
- DANCE
- DANCES

WRITE THE SENTENCE



WHAT IS HE DOING?

- PLAYS FOOTBALL
- PLAY FOOTBALL
- PLAYING FOOTBALL

WRITE THE SENTENCE



WHAT ARE THEY DOING?

- DRAWING
- PAINTING
- CUTTING

WRITE THE SENTENCE

VEHICLES

Look at the picture.
Complete the word.

¹a e p a e
²t
³s
⁴t
⁵v a
⁶b ⁷c y c e
 u
 k

airplane

truck

ship

train

van

bicycle

car

WORKSHEET 88

Copyright(2018) Booboo Books

Transportation Word Search

Name: _____

Class: _____

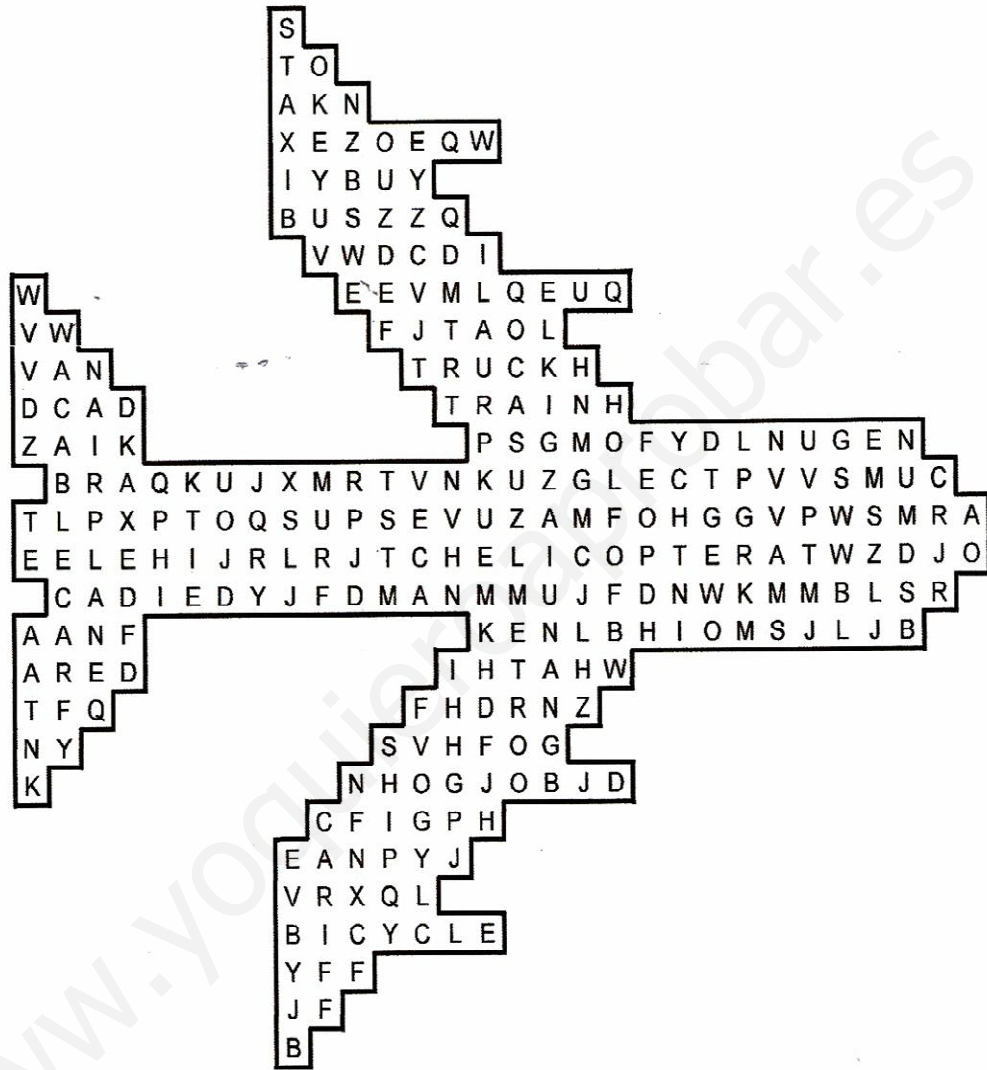

bus



car



taxi



ship



airplane



truck



bicycle

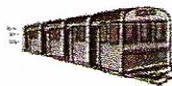

train



metro



van



cable car



helicopter

Weather Word Search

Name: _____

Class: _____



Y
O F
C W E
L I W J
O N H N Q
U D X D R Y
D Y B B K S H
Y N E F H O T J
R Z V J W U Y B H
K L X P T N C M E
R

F G G W F J M Z Z J A T Z Z J L O U W F E
J X Y P I B B O R I K N J B S V I B H
S N O W Y A G U N S K H M C O L D
T K A W L A I Y E T I W W C Q
Q S P W K C P A V O N I I
E Q G S G T S U N N Y



rainy



sunny



hot



cold



windy



snowy



cloudy



dry

Find the names of the months. Colour the months.

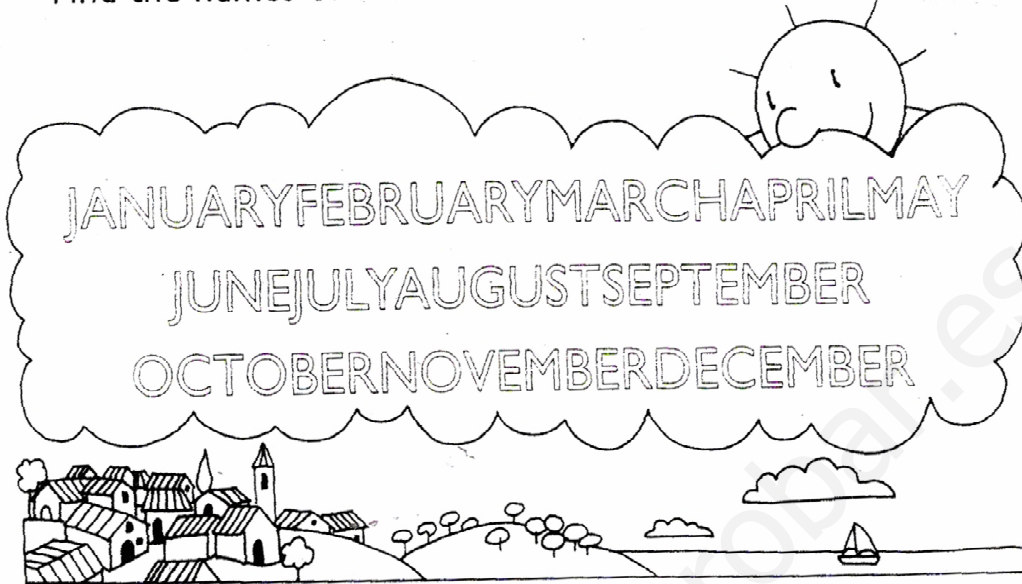

Complete the puzzle. What month isn't in the puzzle?

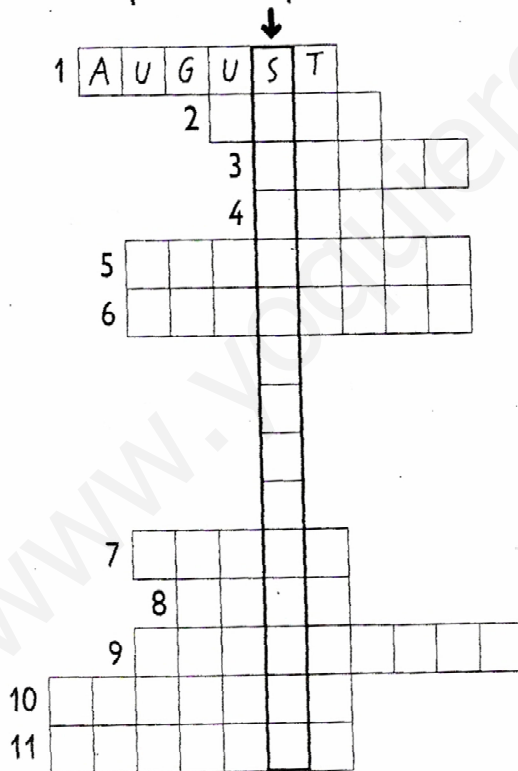

- 1 The month after July.
- 2 The month before August.
- 3 The month after February.
- 4 A month with three letters.
- 5 The month after October.
- 6 The month before March.
- 7 The month before May.
- 8 The month after May.
- 9 The month after August.
- 10 The month before November.
- 11 The month before February.
- 12 The missing month is _____.
- 13 What's the mystery sentence?

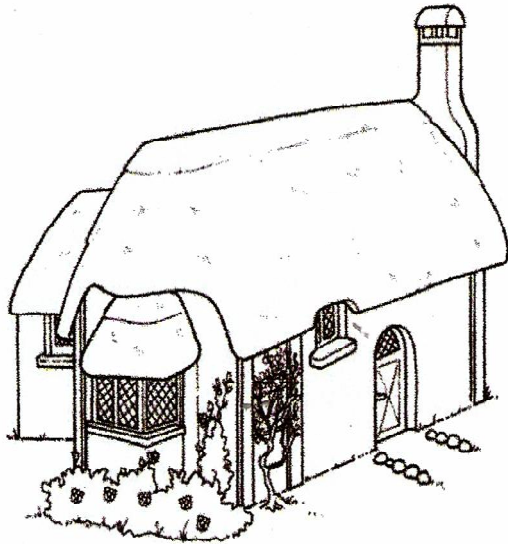

COTTAGE

I LIVE IN A COTTAGE IN WALES.
THIS IS A TYPICAL HOUSE IN BRITAIN.
THERE IS A KITCHEN, THERE ARE TWO BEDROOMS, TWO
BATHROOMS, A LIVING ROOM, A DINING ROOM AND A NICE
GARDEN.

COMPLETE:

| ACTIONS | ROOM |
|-----------------|------|
| SLEEP | |
| WASH | |
| WATCH TV | |
| EAT | |
| COOK | |
| PICK UP FLOWERS | |

WHERE DO YOU LIVE?

Clothes



I'm wearing a big t-shirt, trousers, socks and shoes.

I'm wearing a red and yellow t-shirt and a red skirt. My socks are white and my shoes are red.



I'm wearing grey trousers, a brown jumper, white socks and brown shoes. My hat is red.

I'm wearing a white shirt and a long green cardigan. My trousers are blue and my shoes are purple.



I'm wearing my favourite yellow jumper, my blue jeans, socks and yellow shoes.

Clothes Spelling

Name _____

Date _____

Directions: You will see four words. Choose the correct spelling of the word that matches the picture. Write the letter of your choice in the blank provided.

____ 1) A. pants B. pannts C. pantss D. pantes



____ 2) A. dress B. dre C. dresss D. dreses



____ 3) A. shoes B. shues C. shoess D. shos



____ 4) A. jeens B. jeanns C. jeanss D. jeans



____ 5) A. jaket B. jacket C. jacet D. jaccet



____ 6) A. scirt B. sskirt C. sikrt D. skirt



____ 7) A. aht B. hat C. ht D. ha



____ 8) A. T-sshirt B. T-shirt C. T-suhirt D. T-shirtc



____ 9) A. shirt B. sshirt C. shrt D. sirt



____ 10) A. shurts B. shorts C. shortss D. shortes



____ 11) A. cuat B. coat C. koat D. comat



____ 12) A. sweeter B. ssweater C. sweter D. sweater



1 Match.

trousers
shoes
T-shirt
jumper
skirt

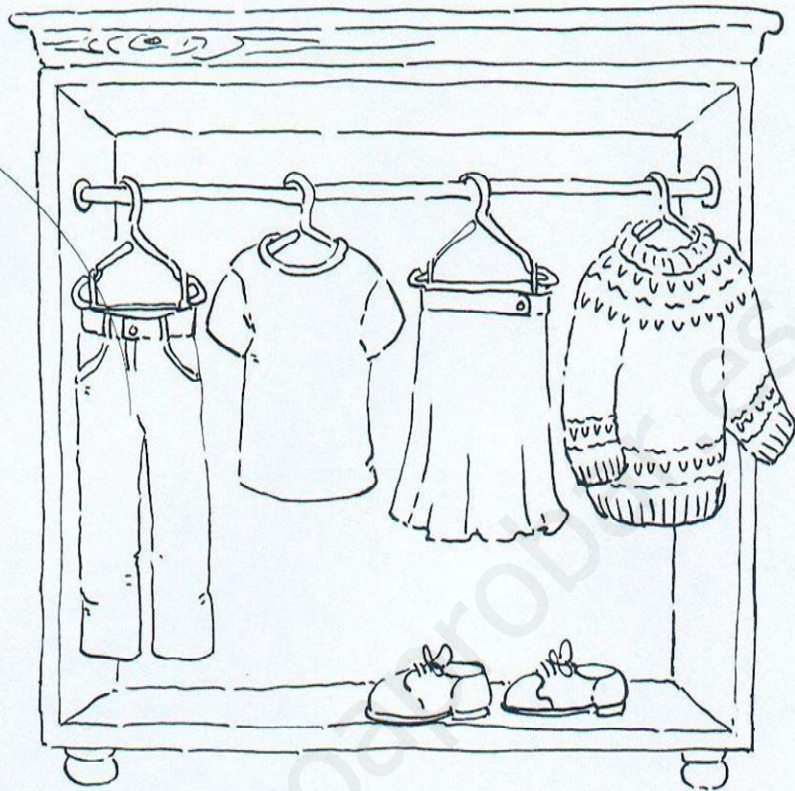

2 Write and colour.

Look at the blue trousers, the red _____,
the yellow _____, and the green _____.





School Supplies Crossword

Name: _____

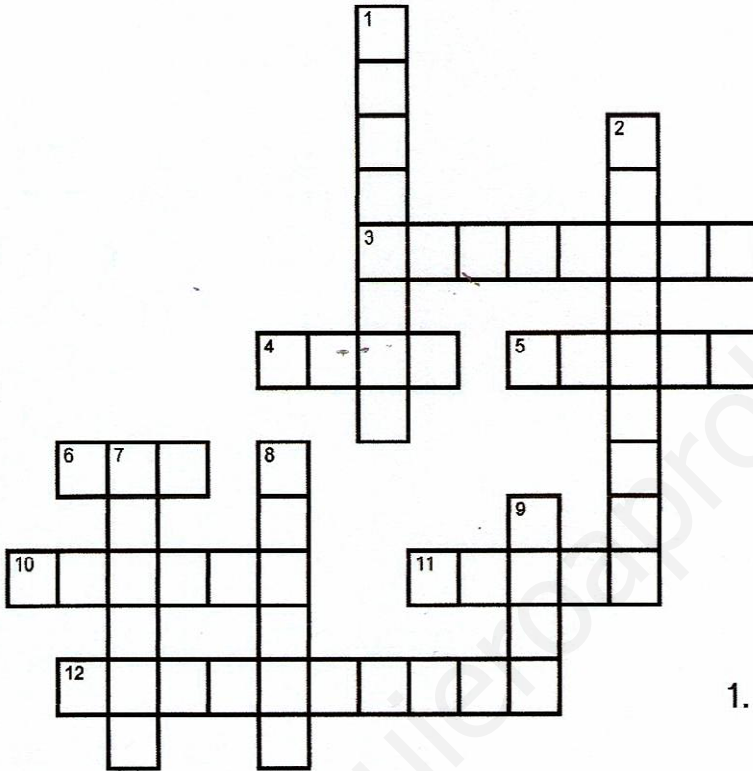



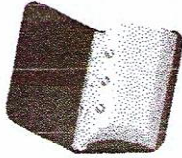
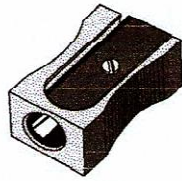
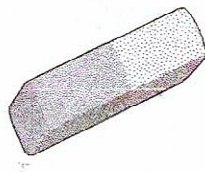

Class: _____

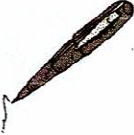

Down

1. 
2. 
7. 
8. 
9. 

Across

3. 
4. 
5. 
6. 
10. 
11. 
12. 

School Picture Test

Name: _____

10

Circle the correct word.

teacher notebook
pupil  board
schoolbag pencase

board  pencase
map globe
notebook classroom

globe teacher
schoolbag  pupil
pencase book

notebook  pencase
map book
board classroom

globe pupil
board  map
book teacher

globe schoolbag
map  classroom
board pencase

schoolbag pencase
board  teacher
classroom book

notebook  map
book globe
classroom pupil

schoolbag pupil
notebook  map
globe board

teacher classroom
schoolbag  pupil
notebook teacher

WHERE IS - ARE ...?

Look at the picture and complete the sentences with the right preposition and object, then answer to the questions.

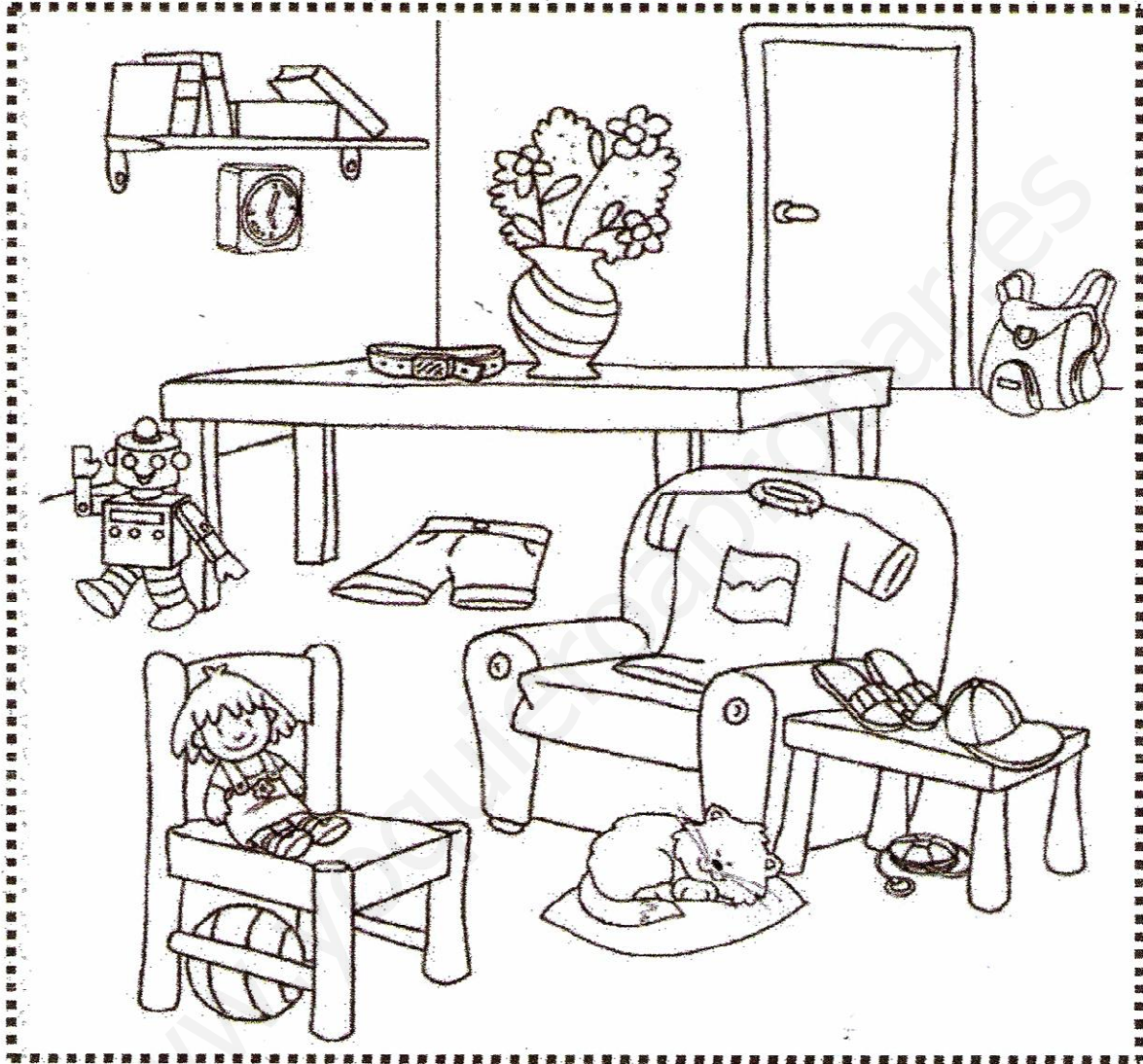

The ball is under the chair.

The books are

The school bag is

The shorts are

The t-shirt is

The vase is

The flip-flops are

The cap is

The robot is



Answer to the questions.

Are there five flowers in the vase?

Is there a dog?

Is the doll on the armchair?

Is the belt on the table?

Is there a yo-yo under the coffee table?

Where is the mouse?

Name: _____

Draw a line to match picture to sentence.

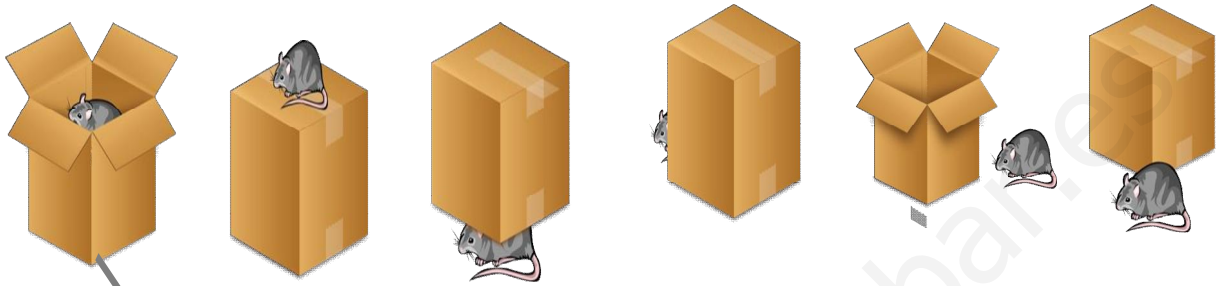

The mouse
is **next to**
the box.

The mouse
is **in front of**
the box.

The mouse
is **in** the
box.

The mouse
is **on** the
box.

The mouse
is **under**
the box.

The mouse
is **behind**
the box.

What is she/he doing?

Look at the pictures and write affirmative, negative and interrogative sentences in the Present continuous. Use the verb in brackets.

A - She **is** reading a book. (read)
 I- Is she reading a book?
 N- She isn't reading a book. →



A - He **is** _____ (walk)
 I- Is _____?
 N- He isn't _____.



A - She _____ (play)
 I- Is _____?
 N- He isn't _____.



A - He **is** _____ (walk)
 I- Is _____?
 N- He isn't _____.



A - He **is** _____ (run)
 I- Is _____?
 N- He isn't _____.



A - She **is** _____ (sleep)
 I- Is _____?
 N- He isn't _____.









A - He **is** _____ (write)
 I- Is _____?
 N- He isn't _____.



A - He **is** _____ (cycle)
 I- Is _____?
 N- He isn't _____.

PERSONAL PRONOUNS

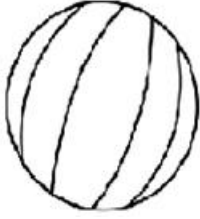
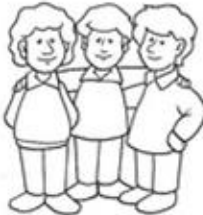
1 Write the personal pronouns under the picture.

| | | | |
|---|---|---|--|
|  yo |  él |  ella |  tú |
| | | | |
|  Ello |  Nosotros |  Vosotros |  Ellos |
| | | | |

2 Write the personal pronouns

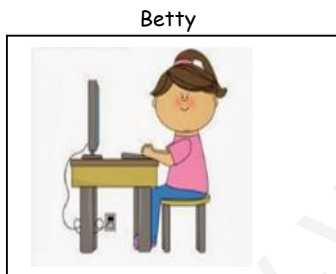

_____ is playing on the computer.



_____ are playing in the sandbox.



_____ am doing a puzzle.

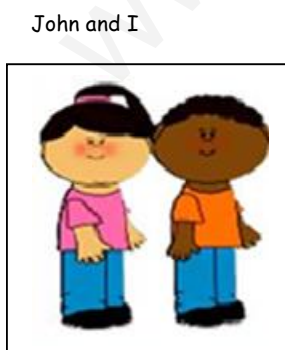

_____ are friends.

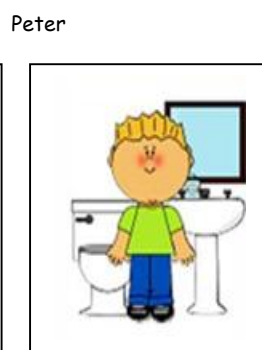

_____ is in the bathroom.

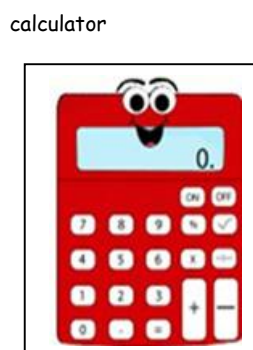

_____ is red.



_____ are going to school.

Complete with *have got* / *has got*

To have got

1. Jack _____ a dog.

2. I _____ toys.

3. Jessica _____ a Granny.

4. We _____ many books.

5. Julia _____ a bear.

6. They _____ a kitten.

7. John _____ an umbrella.

8. We _____ a house.

9. Nick and Mary _____ a dog.

10. My brother _____ a bike.

